

# TEST REPORT

of

## RE Directive (2014/53/EU) EN 301 489-1/17

**Product :** Bluetooth 5.0, 802.15.4 module  
**Brand:** Fanstel  
**Model:** BT840, BT840F, BT840E, BT840H  
**Model Difference:** Antenna. Please see page 5 for detail  
**Applicant:** Fanstel Corporation, Taipei  
**Address:** 10F-10, No. 79, Sec. 1, Hsin Tai Wu Rd.,  
Hsi-Chih, New Taipei City 221 Taiwan

Test Performed by:

**International Standards Laboratory Corp. LT Lab.**



TEL: +886-3-263-8888 FAX: +886-3-263-8899

No. 120, Lane 180, Hsin Ho Rd., Lung-Tan Dist., Tao Yuan City 325,  
Taiwan

Report No.: **ISL-19LR205E489-R2**

Issue Date : **2022/02/07**



Test results given in this report apply only to the specific sample(s) tested and are traceable to national or international standard through calibration of the equipment and evaluating measurement uncertainty herein.

The uncertainty of the measurement does not include in consideration of the test result unless the customer required the determination of uncertainty via the agreement, regulation or standard document specification.

This test report shall not be reproduced except in full, without the written approval of International Standards Laboratory Corp.

## VERIFICATION OF COMPLIANCE

**Applicant:** Fanstel Corporation, Taipei  
**Equipment Under Test:** Bluetooth 5.0, 802.15.4 module  
**Brand Name:** Fanstel  
**Model Number:** BT840, BT840F, BT840E, BT840H  
**Model Different:** Antenna. Please see page 5 for detail  
**Date of Test:** 2019/8/6 ~2019/8/13  
**Date of EUT Received:** 2019/8/5

APPLICABLE STANDARDS	
EN 301 489 –1 v2.2.3: 2019	EN 301 489 –17 v3.2.4: 2020
EMI: EN 55032:2015 Class B	
EMS: EN 55024: 2010+A1:2015	
EN61000-4-2:2009	EN 61000-4-3:2006+A1:2008 +A2:2010

In the configuration tested, the EUT complied with the standards specified above.

**Remarks:**

This report details the results of the testing carried out on one sample, the results contained in this test report do not relate to other samples of the same product. The manufacturer should ensure that all products in series production are in conformity with the product sample detailed in this report. This report may only be reproduced and distributed in full. If the product in this report is used in any configuration other than that detailed in the report, the manufacturer must ensure the new system complies with all relevant standards. Any mention of **International Standards Laboratory Corp.** or testing done by in connection with distribution or use of the product described in this report must be approved by **International Standards Laboratory Corp.** in writing.

*Test By:* Jason Chao *Date:* 2022/02/07  
*Jason Chao / Senior Engineer*

*Prepared By:* Elisa Chen *Date:* 2022/02/07  
*Elisa Chen / Senior Engineer*

*Approved By:* Jerry Liu *Date:* 2022/02/07  
*Jerry Liu / Technical Manager*

## Version

Version No.	Date	Description
00	2019/08/30	Initial creation of document
01	2022/02/07	Upgrade the standard version (See Note)

Note:

After comparing with two versions of EN 301 489 standards for this application, the difference is as below table. No testing and test report modified is needed, hence, the test configuration and test results of this report are cited from the original report.

Original rule	New rule	Remark
EN 301 489-1 V2.1.1	EN 301 489-1 V2.2.3	No tests need to be update
EN 301 489-17 V3.1.1	EN 301 489-17 V3.2.4	

## TABLE OF CONTENTS

<b>1. GENERAL DESCRIPTION.....</b>	<b>5</b>
1.1 DESCRIPTION OF EQUIPMENT UNDER TEST (EUT).....	5
1.2 GENERAL DESCRIPTION OF APPLIED STANDARDS .....	6
1.3 DESCRIPTION OF TEST MODES:.....	6
1.4 TEST FACILITY:.....	8
1.5 MODIFICATION LIST:.....	8
1.6 TEST CONDITION:.....	8
1.7 EQUIPMENT LIST:.....	9
1.8 CONFIGURATION OF TESTED SYSTEM .....	12
1.9 EXCLUSION BAND .....	13
<b>2. RADIO DISTURBANCE.....</b>	<b>15</b>
2.1 TEST CONFIGURATION: .....	15
2.2 SPECIAL CONDITIONS:.....	15
2.3 SUMMARY OF TEST RESULTS.....	15
2.4 ENCLOSURE OF ANCILLARY EQUIPMENT MEASURED ON A STANDALONE BASIS. ....	16
2.5 DC POWER INPUT/OUTPUT PORTS MEASUREMENT.....	23
2.6 AC MAINS POWER INPUT/OUTPUT PORTS MEASUREMENT. ....	25
2.7 HARMONIC CURRENT EMISSIONS (AC MAINS INPUT PORT) MEASUREMENT. REFER TO EN 301 489-1 SECTION 8.5.....	28
2.8 VOLTAGE FLUCTUATIONS AND FLICKER (AC MAINS INPUT PORT) MEASUREMENT. REFER TO EN 301 489-1 SECTION 8.6.....	31
2.9 TELECOMMUNICATION PORT MEASUREMENT. REFER TO EN 301 489-1 SECTION 8.7.....	32
<b>3. IMMUNITY .....</b>	<b>33</b>
3.1 TEST CONFIGURATION: .....	33
3.2 SPECIAL CONDITIONS:.....	33
3.3 SUMMARY OF TEST RESULTS: .....	33
3.4 PERFORMANCE CRITERIA DESCRIPTION:.....	34
3.5 ELECTROSTATIC DISCHARGE MEASUREMENT. REFER TO EN 301 489-1 SECTION 9.3.....	37
3.6 RADIO FREQUENCY ELECTROMAGNETIC FIELD (80MHz TO 6GHz) MEASUREMENT. REFER TO EN 301 489-1 SECTION 9.2.....	40
3.7 FAST TRANSIENTS, COMMON MODE MEASUREMENT. REFER TO EN 301 489-1 SECTION 9.4.....	42
3.8 SURGES MEASUREMENT. REFER TO EN 301 489-1 SECTION 9.8 .....	43
3.9 RADIO FREQUENCY, COMMON MODE MEASUREMENT. REFER TO EN 301 489-1 SECTION 9.5.....	44
3.10 TRANSIENTS AND SURGES IN THE VEHICULAR ENVIRONMENT MEASUREMENT. REFER TO EN 301 489-1 SECTION 9.6.....	45
3.11 VOLTAGE DIPS AND INTERRUPTIONS MEASUREMENT. REFER TO EN 301 489-1 SECTION 9.7.....	47
<b>ESD TEST POINT.....</b>	<b>48</b>
<b>PHOTOGRAPHS OF TEST SETUP.....</b>	<b>51</b>
<b>PHOTOGRAPHS OF EUT .....</b>	<b>59</b>

# 1. General Description

## 1.1 Description of Equipment under Test (EUT)

Product Name:	Bluetooth 5.0, 802.15.4 module
Brand:	Fanstel
Model:	BT840, BT840F, BT840E, BT840H
Model different:	Antenna. Please see table below for detail.
Power Supply:	5Vdc by USB port
RF function	BT 5.0 + IEEE 802.15.4 (Thread, Zigbee)

### Model Summaries

module	BT840F	BT840	BT840E	BT840H
SoC	nRF52840-QIAA	nRF52840-QIAA	nRF52840-QIAA	nRF52840-QIAA
Size	15x20.8x1.9mm	14x16x1.9mm	14x16x1.9mm	14x16x1.9mm
BT Antenna	PCB trace	PCB trace	u.FL	MHF4
BT range at 1Mbps	510 meters	180 M, estimated		
BT range at 125 Kbps	930 meters		>1000 M	>1000 M

Remark: The above DUT's information was declared by manufacturer. Please refer to the specifications or user's manual for more detailed description.

## 1.2 General Description of Applied Standards

The EUT According to the Specifications, it must comply with the requirements of the following standards:

ETSI EN 301 489-1 V2.2.3:

ElectroMagnetic Compatibility (EMC) standard for radio equipment and services;  
Part 1: Common technical requirements; Harmonised Standard covering the essential requirements of article 3.1(b) of Directive 2014/53/EU and the essential requirements of article 6 of Directive 2014/30/EU

ETSI EN 301 489-17 V3.2.4:

Part 17: Specific conditions for Broadband Data Transmission Systems; Harmonised Standard covering the essential requirements of article 3.1(b) of Directive 2014/53/EU

EN 55032:2015+AC:2016, CISPR 32: 2015+COR1:2016:

Electromagnetic compatibility of multimedia equipment - Emission requirements.

EN 55024:2010 – Information technology Equipment – Immunity Characteristics - Limits and methods of measurement

## 1.3 Description of Test Modes:

The transmitter shall be modulated with normal test modulation as specified for that type of equipment. Where transmitters do not have a modulation input port, the internal equipment modulation shall be used.

The wanted signals and/or controls required to establish a communications link shall be defined by the manufacturer.

The transmitter shall be operated at its maximum rated RF output power as specified for that type of equipment. The manufacturer may provide a suitable companion receiver that can be used to set up a communications link and/or to receive messages.

The tests shall be made exercising all primary functions in the most representative mode consistent with typical applications. The test sample shall be configured in a manner consistent with typical installation practice.

## Test Plan

		Config 1	Config 2	Config 3	Config 4
	Applicable standard	EN 301489-17			
	Accessories	UE	UE	UE	UE
		+ Smart phone	+ Smart phone	+ Smart phone	+ Smart phone
		BT&IEEE 802.15.4 (Thread, Zigbee) link(BT840E) Antenna:Ant0	BT&IEEE 802.15.4 (Thread, Zigbee) link(BT840H) Antenna:Ant0	BT&IEEE 802.15.4 (Thread, Zigbee) link(BT840F)	BT&IEEE 802.15.4 (Thread, Zigbee) link(BT840)
EN No.	Description				
8.2	radiated emission (30M-1GHz) (1-6GHz)	measured	pretest	pretest	pretest
8.3	conducted emission (DC Power)	N/A	N/A	N/A	N/A
8.4	conducted emission (AC Power)	measured	N/A	N/A	N/A
8.5	harmonic current emissions	N/A	N/A	N/A	N/A
8.6	voltage fluctuations and flicker	N/A	N/A	N/A	N/A
8.7	Conducted emission (wired network)	N/A	N/A	N/A	N/A
9.2	RF electromagnetic field (80MHz to 6GHz)	measured	measured	measured	measured
9.3	electrostatic discharge	measured	measured	measured	measured
9.4	fast transients common mode	N/A	N/A	N/A	N/A
9.5	RF common mode 0,15 MHz to 80 MHz	N/A	N/A	N/A	N/A
9.6	transients and surges	N/A	N/A	N/A	N/A
9.7	voltage dips and interruptions	N/A	N/A	N/A	N/A
9.8	surges, line to line and line to ground	N/A	N/A	N/A	N/A

*Note 1: the test plan was accepted by the applicant*

#### **1.4 Test Facility:**

The 10m anechoic chamber radiated emission measurement facilities used to collect the data are located at <LT Lab.> Address: No. 120, Lane 180, Hsin Ho Rd. Lung-Tan Dist., Tao Yuan City 325, Taiwan, The sites are constructed in conformance with the requirements of ANSI C63.7, ANSI C63.4 and CISPR Publication 22.

The 966 anechoic chamber radiated emission measurement (Above 1GHz) facilities used to collect the data are located at <LT Lab.> Address: No. 120, Lane 180, Hsin Ho Rd. Lung-Tan Dist., Tao Yuan City 325, Taiwan, The sites are constructed in conformance with the requirements of ANSI C63.7, ANSI C63.4 and CISPR Publication 22.

The AC power line conducted emission, flicker and all of immunity measurement facilities used to collect the data are located at <LT Lab.> Address: No. 120, Lane 180, Hsin Ho Rd. Lung-Tan Dist., Tao Yuan City 325, Taiwan, The sites are constructed in conformance with the requirements of ANSI C63.7, ANSI C63.4 and CISPR Publication 22.

#### **1.5 Modification List:**

No modification by International Standards Laboratory Corp.

#### **1.6 Test Condition:**

Refer to EN 301 489-1, Section 4 and EN 301 489-17, Section4 for the details.



### 1.7 Equipment List:

Location Con03	Equipment Name	Brand	Model	S/N	Last Cal. Date	Next Cal. Date
Conduction 03	EMI Receiver 13	ROHDE & SCHWARZ	ESCI	101015	07/25/2019	07/25/2020
Conduction 03	ISN T4 09	Teseq GmbH	ISN T400A	49914	08/11/2019	08/11/2020
Conduction 03	ISNT8 08	Teseq GmbH	ISN T800	36155	02/19/2019	02/19/2020
Conduction 03	LISN 15	R&S	ENV216	101335	11/22/2018	11/22/2019
Conduction 03	LISN 22	R&S	ENV216	101478	08/13/2019	08/13/2020
Conduction 03	Conduction 03 -1 Cable	WOKEN	CFD 300-NL	Conduction 03 -1	08/23/2019	08/23/2020
Conduction 03	Capacitive Voltage Probe	FCC	F-CVP-1	68	02/19/2019	02/19/2020
Conduction 03	Current Probe	SCHAFFNER	SMZ 11	18030	02/19/2019	02/19/2020

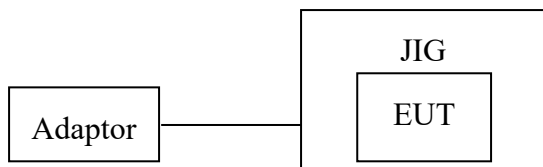
Location Chmb12	Equipment Name	Brand	Model	S/N	Last Cal. Date	Next Cal. Date
Radiation (Chamber12)	BILOG Antenna 18	Schwarzbeck	Schwarzbeck VULB 9168+EMCI-N -6-05	646	01/29/2019	01/29/2020
Radiation (Chamber12)	Preamplifier 26	EMCI	EMC9135	980297	01/23/2019	01/23/2020
Radiation (Chamber12)	Coaxial Cable Chmb 12-10M-01	PEWC	CFD400-NL	Chmb 12-10M-01	08/23/2019	08/23/2020
Radiation (Chamber12)	EMI Receiver 18	ROHDE & SCHWARZ	ESCI	101392	06/14/2019	06/14/2020

Chamber 19(966)					
Equipment Type	Manufacturer	Model Number	Serial Number	Last Cal.	Cal. Due.
966 Chamber	Chance Most	Chamber 19	N/A	08/13/2019	08/12/2020
Spectrum analyzer	R&S	FSP40	100116	01/10/2019	01/09/2020
EMI Receiver	R&S	ESR3	102461	08/08/2018	08/07/2020
Loop Antenna(9K-30M)	EM	EM-6879	271	05/31/2019	05/30/2020
Bilog Antenna (30M-1G)	SCHWARZBECK	VULB9168 w 5dB Att	736	01/29/2019	01/28/2020
Horn antenna (1G-18G)	SCHWARZBECK	9120D	9120D-1627	06/17/2019	06/16/2020
Horn antenna (18G-26G)	Com-power	AH-826	081001	11/21/2017	11/20/2019
Horn antenna (26G-40G)	Com-power	AH-640	100A	03/29/2019	03/28/2021
Preamplifier (9k-1000M)	HP	8447F	3113A06362	01/14/2019	01/13/2020
Preamplifier(1G-26G)	Agilent	8449B	3008A02471	10/29/2018	10/28/2019
Preamplifier (26G-40G)	MITEQ	JS4-26004000-27 -5A	818471	05/06/2019	05/05/2020
RF Cable (9k-18G)	HUBER SUHNER	SUCOFLEX 104A	MY1397/4A	01/17/2019	01/16/2020
RF cable (18G~40G)	HUBER SUHNER	Sucoflex 102	27963/2&37421 /2	11/12/2018	11/11/2019
Turn Table	MF	Turn Table-19	Turn Table-19	N/A	N/A
Mast Tower	MF	JSDES-15A	1308283	N/A	N/A
Controller	MF	MF-7802BS	MF780208460	N/A	N/A
AC power source	T-Power	TFC-1005	40006471	N/A	N/A
Signal Generator	Anritsu	MG3692A	20311	01/09/2019	01/08/2020
2.4G Filter	Micro-Tronics	Brm50702	76	12/25/2018	12/24/2019
5G Filter	Micro-Tronics	Brm50716	005	12/25/2018	12/24/2019
Tunable Notch Filter (800 to 1000)	K&L	3TNF-00082	478	12/25/2018	12/24/2019
Tunable Notch Filter (1700 to 2000)	K&L	5TNF-00082	335	12/25/2018	12/24/2019
Band reject filter850	WI	Wrc814-859	3	12/25/2018	12/24/2019
Band reject filter900	WI	Wrc860-935	3	12/25/2018	12/24/2019
Band reject filter1800	WI	Wrc1690-1805	3	12/25/2018	12/24/2019
Band reject filter1900	WI	Wrc1830-1930	3	12/25/2018	12/24/2019
Test Software	Audix	E3 Ver:6.12023	N/A	N/A	N/A

Location	Equipment Name	Brand	Model	S/N	Last Cal. Date	Next Cal. Date
EN61K-4-2	ESD Gun 12	EM TEST	Dito	P1650188689	05/07/2019	05/07/2020
EN61K-4-2	ESD Gun 07	NoiseKen	ESS-2002EX	ESS0878638	01/31/2019	01/31/2020
EN61K-4-3	Broadband Log-Periodic Antenna	AR	AT1080	310698	N/A	N/A
EN61K-4-3	Horn Antenna RF-01	AR	ATS700M11G	0335864	N/A	N/A
EN61K-4-3	Amplifier 80Mz~1GHz 250W	AR	250W1000A	312494	N/A	N/A
EN61K-4-3	Amplifier 800MHz~4.2GHz 50W	AR	50S1G4M1	312762	N/A	N/A
EN61K-4-3	Amplifier 4.0~8.0GHz 35W	AR	35S4G8AM1	0335752	N/A	N/A
EN61K-4-3	Broadband Coupler 80M~1GHz	Amplifier Research	DC6180A	0341805	N/A	N/A
EN61K-4-3	Coaxial Cable	INSULATED	NPS-4806-2360-NP3	108599.003.01.03	N/A	N/A
EN61K-4-3	Broadband Coupler 0.8G~4.26GHz	AR	DC7144A	0335226	N/A	N/A
EN61K-4-3	Broadband Coupler 4G~8GHz	AR	DC7350A	0335817	N/A	N/A
EN61K-4-3	Signal Generator 07	ROHDE&SCHWARZ	SMB100A	107780	10/28/2018	10/28/2019
EN61K-4-4	EFT and SURGE Test System	EM TEST	UCS-500 M6B	V0728102674	02/14/2019	02/14/2020
EN61K-4-4	Capacitive Coupling Clamp	EM TEST	HFK	0907-106	02/14/2019	02/14/2020
EN61K-4-5	CDN-UTP8 ED3	EMC-PARTNER	CDN-UTP8	1509	04/02/2019	04/02/2020
EN61K-4-5	SURGE-TESTER	EMC Partner	MIG0603IN3	523	04/02/2019	04/02/2020
EN61K-4-6	CDN M2+M3 02	Frankonia	CDN M2+M3	A3011024	08/20/2019	08/20/2020
EN61K-4-6	CDN T2 04	FCC Inc.	FCC-801-T2	02067	08/17/2019	08/17/2020
EN61K-4-6	CDN T4 06	FCC Inc.	FCC-801-T4	02068	06/24/2019	06/24/2020
EN61K-4-6	CDN T8-10 2	Teseq GmbH	CDN T8 10	41241	03/26/2019	03/26/2020
EN61K-4-6	Coaxial Cable 4-6 02-1			4-6 02-1	N/A	N/A
EN61K-4-6	Conducted Immunity Test System 02	Frankonia	CIT-10-75-DC	126B1301/2014	03/25/2019	03/25/2020
EN61K-4-6	EM-Clamp	Schaffner	KEMZ-801	19215	11/08/2018	11/08/2019
EN61K-4-8	Magnetic Field Immunity Loop	FCC	F-1000-4-8-L-1M	01037	05/27/2019	06/05/2020
EN61K-4-8	Magnetic Field Test Generator	FCC	F-1000-4-8-G-125A	01038	05/27/2019	06/05/2020
EN61K-4-11	Voltage Dip and UP Simulator	NoiseKen	VDS-2002	VDS0640162	11/06/2018	11/06/2019
EN61K-4-34	Voltage Dip and UP Simulator 50A	PRIMA	DRP61011CX	PR17096386	01/03/2019	01/03/2020
EN61K-3-2/3, EN61K-3-11-1 2	(Harmonic/Flicker) MX Series CTS Compliance Test System	California Instruments	MX60T04GH 10400	72793	08/06/2019	08/06/2020

PS: N/A => The equipment does not need calibration.

## 1.8 Configuration of Tested System



-----remote-----

Smart phone

**Table 1-1 Support Equipment Used in Tested System**

Item	Equipment	Mrf/Brand	Model name	Series No	Data Cable	Power Cable
1	adaptor	Apple	A1385	N/A	N/A	Shielded /0.6m
2	Smart phone	hTC	PL99110	N/A	N/A	N/A

**I/O Cable Condition of EUT and Support Units**

Description	Path	Cable Length	Cable Type	Connector Type
USB power cable	Adaptor USB port to JIG micro USB port	0.6m	Non-Shielded	Metal Head

**Note:** All the above equipment/cables were placed in worse case positions to maximize emission signals during emission test.

**Grounding:** Grounding was in accordance with the manufacturer's requirements and conditions for the intended use.

## 1.9 Exclusion band

### For EN301489-1

Exclusion band for transmitters or the transmitter part of transceivers

Channelized Equipment

For channelized equipment the exclusion band shall extend 250 % of the channel width either side of the transmitter centre frequency.

NOTE: Exclusion band of 250 % is based on the ITU Radio Regulations, as the boundary between OOB and Spurious Domain.

Non-Channelized Equipment

For non-channelized equipment the exclusion band shall extend 250 % of the occupied bandwidth either side of the transmitter centre frequency.

NOTE: Exclusion band of 250 % is based on the ITU Radio Regulations , as the boundary between OOB and Spurious Domain.

Exclusion band for receivers or the receiver part of transceivers

Channelized Equipment

For channelized equipment the exclusion band shall be calculated by using the following formulae:

For the lower edge for the exclusion band:

$$EXband(lower) = BandRX(lower) - nChWRX$$

and for the upper edge of the exclusion band:

$$EXband(upper) = BandRX(upper) + nChWRX$$

Where n = number of channel widths required for exclusion band.

For equipment that support multiple channel widths the Channel Width used should be the widest support by the EUT.

Where the present document is being used in a stand-alone basis (i.e. with no reference to other relevant radio technology parts of ETSI EN 301 489 series), the value of n shall be 1.

Non-Channelized Equipment

For non-channelized equipment the exclusion band shall be calculated by using the following formula: For the lower edge for the exclusion band:

$$EXband(lower) = BandRX(lower) - nBWRX$$

and for the upper edge of the exclusion band:

$$EXband(upper) = BandRX(upper) + nBWRX$$

Where n = multiple of whole bandwidths required to define exclusion band.

Bandwidth of Receiver is the occupied bandwidth of the corresponding transmitter signal.

Where the present document is being used in a stand-alone basis (i.e. with no reference to other relevant radio technology parts of ETSI EN 301 489 series), the value of n shall be 1

**For EN301489-17**

The frequencies on which the transmitter part of the EUT is intended to operate shall be excluded from conducted and radiated emission measurements when performed in transmit mode of operation.

The exclusion band for immunity testing of equipment operating in the 2,4 GHz band shall be:  
lower limit of exclusion band = lowest allocated band edge frequency -120 MHz, i.e. 2 280 MHz;  
upper limit of exclusion band = highest allocated band edge frequency +120 MHz, i.e. 2 603,5MHz.

The exclusion band for immunity testing of equipment operating in the 5 GHz Wi-Fi band shall be:  
lower limit of exclusion band = lowest allocated band edge frequency -270 MHz, i.e. 4 880 MHz;  
upper limit of exclusion band = highest allocated band edge frequency +270 MHz, i.e. 5 995 MHz.

The exclusion band for immunity testing of equipment operating in the 5,8 GHz band shall be:  
lower limit of exclusion band = lowest allocated band edge frequency -270 MHz, i.e. 5 455 MHz;  
as the immunity requirements have an upper frequency range of 6 GHz and any upper edge exclusion band would be greater than this for the 5,8 GHz band. The above frequency shall also be regarded as the upper end of the test range.

## 2. Radio Disturbance

EN 301 489-17  
EN 55032 Class B

### 2.1 Test Configuration:

Refer to EN 301 489-1, Section 8.1.

### 2.2 Special Conditions:

EN301489-17

No special conditions shall apply to UE in the scope of the present document.

### 2.3 Summary of Test Results

Test Items	Reference section	Result
Enclosure of ancillary equipment measured on a stand alone basis, EN55032, Class B	EN 301 489-1 Section 8.2 EN55032 Annex A.2	PASS
DC mains power input/output ports	EN 301 489-1 Section 8.3	N/A
AC mains power input/output ports EN55032, Class B	EN 301 489-1 Section 8.4 EN55032 Annex A.3	PASS
Harmonic current emission, Class A	EN 301 489-1 Section 8.5 EN61000-3-2	N/A
Voltage fluctuations and flicker	EN 301 489-1 Section 8.6 EN61000-3-3	N/A
Telecommunication Port	EN 301 489-1 Section 8.7 EN55032 Annex B.2	N/A

## 2.4 Enclosure of ancillary equipment measured on a standalone basis.

### 2.4.1 Test Method:

Standard	Date	Description
EN 55032	2015+AC: 2016	Limits and methods of measurement of radio interference characteristics of information technology equipment.

### Limit: Class B

Table clause	Frequency range MHz	Measurement		Class B limits dB( $\mu$ V/m)
		Distance m	Detector type/ bandwidth	OATS/SAC (see Table A.1)
A4.1	30 – 230	10	Quasi Peak / 120 kHz	30
	230 – 1 000			37
A4.2	30 – 230	3		40
	230 – 1 000			47
Apply only table clause A4.1 or A4.2 across the entire frequency range.				

Table clause	Frequency range MHz	Measurement		Class B limits dB( $\mu$ V/m)
		Distance m	Detector type/ bandwidth	FSOATS (see Table A.1)
A5.1	1 000 – 3 000	3	Average/ 1 MHz	50
	3 000 – 6 000			54
A5.2	1 000 – 3 000		Peak/ 1 MHz	70
	3 000 – 6 000			74
Apply A5.1 and A5.2 across the frequency range from 1 000 MHz to the highest required frequency of measurement derived from Table 1.				

Highest internal frequency ( $F_x$ )	Highest measured frequency
$F_x \leq 108$ MHz	1 GHz
$108$ MHz $< F_x \leq 500$ MHz	2 GHz
$500$ MHz $< F_x \leq 1$ GHz	5 GHz
$F_x > 1$ GHz	$5 \times F_x$ up to a maximum of 6 GHz
NOTE 1 For FM and TV broadcast receivers, $F_x$ is determined from the highest frequency generated or used excluding the local oscillator and tuned frequencies.	
NOTE 2 $F_x$ is defined in 3.1.19.	

The highest internal source of an EUT is above 1GHz.



#### **2.4.2 Test Procedure:**

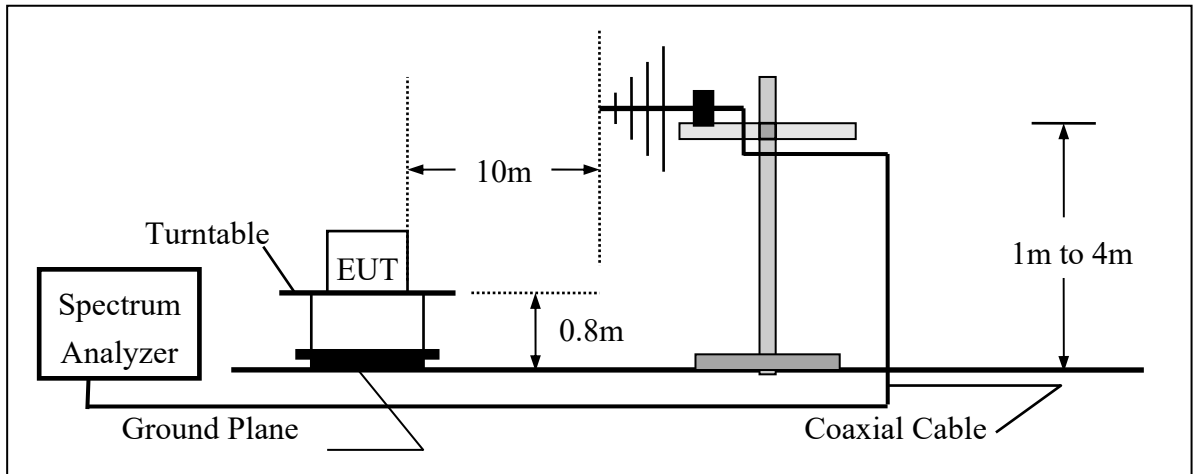
1. EUT was placed on an 0.8m wooden table.
2. Set up EUT with support units and turn on the power of all equipment.
3. Link the EUT with Telecommunication tester, setup the test mode. The transmitter operating at continuously mode and max output rated power.
4. The receive antenna is placed at 10m or 3m (3m for above 1GHz) distance from the EUT and search height from 1-4m.
5. The turntable was slowly rotated to locate the direction of maximum emission. Once maximum direction is determined, the search antenna was raised and lowered in both vertical and horizontal polarizations.

#### **2.4.3 Test Instruments:**

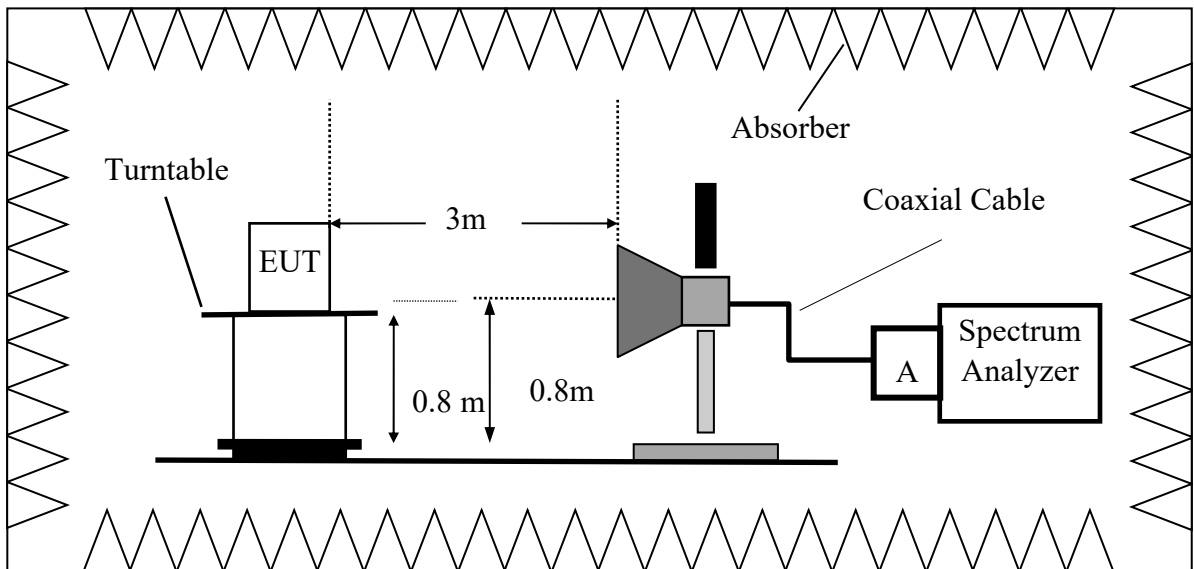
Refer to section 1.7 in this report

### 2.4.4 Test SET-UP (Block Diagram of Configuration)

(A) Radiated Emission Test Set-Up, Frequency Below 1000MHz



(B) Radiated Emission Test Set-UP Frequency Over 1 GHz



### Radiated Emission Measurement Data

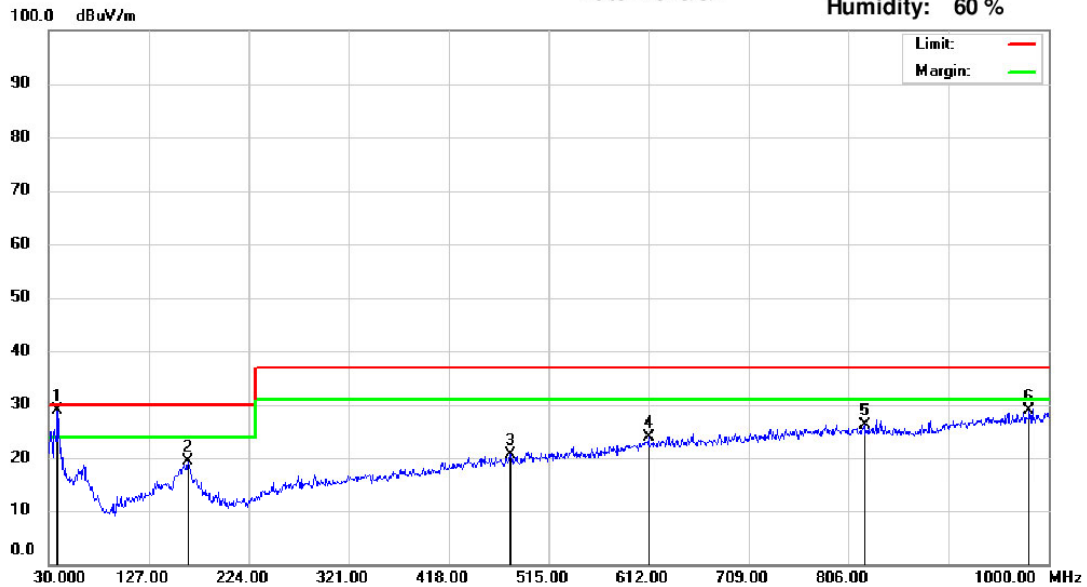
Operation Mode	Config 1	Test Date	2019/08/07
Test by	Jason	Pol	Vertical



Address: No. 120, Lane 180, Hsin Ho Rd., Lung-Tan Dist.,  
Tao Yuan City 325, Taiwan.  
Tel: 03-4071718

Radiated Emission Measurement  
Date: 2019/8/7

Operator: James Kuo  
Temperature: 26 °C  
Humidity: 60 %



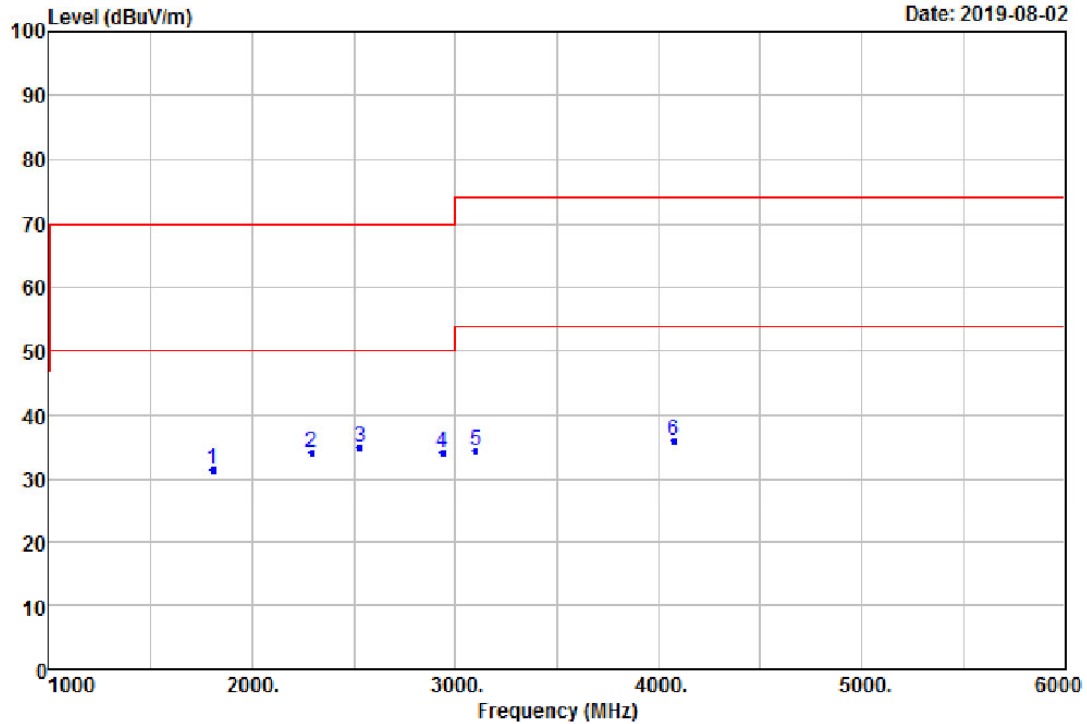
Site : Chamber 12

Polarization: *Vertical*

Mk.	Frequency (MHz)	RX_R (dBuV)	Correct Factor (dB/m)	Emission (dBuV/m)	Limit (dBuV/m)	Margin (dB)	Ant.Pos (cm)	Tab.Pos (deg.)	Detector
1	38.73	46.51	-17.58	28.93	30.00	-1.07	150	335	peak
2	164.83	35.36	-15.86	19.50	30.00	-10.50	150	292	peak
3	478.14	30.98	-10.23	20.75	37.00	-16.25	150	75	peak
4	612.00	31.31	-7.31	24.00	37.00	-13.00	288	360	peak
5	821.52	30.98	-4.78	26.20	37.00	-10.80	221	0	peak
6	981.57	31.19	-2.42	28.77	37.00	-8.23	200	344	peak



International Standard Laboratory Corp.  
Company Address: No.120, Lane 180, Hsin Ho Rd.  
Lung-Tan Dist., Tao Yuan City 325, Taiwan  
Tel: (03)4071718 ; Fax: (03)4071738  
Web: www.isl.com.tw



Condition: 55022/32 B PK 3m VERTICAL  
Site : Chamber 19

Operator : jason

	Freq	Read Level	Factor	Level	Limit Line	Over Limit	Remark	Pol/Phase
	MHz	dBuV	dB/m	dBuV/m	dBuV/m	dB		
1	1805.00	50.19	-18.86	31.33	70.00	-38.67	Peak	VERTICAL
2	2290.00	49.96	-15.75	34.21	70.00	-35.79	Peak	VERTICAL
3	2530.00	50.60	-15.76	34.84	70.00	-35.16	Peak	VERTICAL
4	2935.00	49.00	-14.91	34.09	70.00	-35.91	Peak	VERTICAL
5	3100.00	48.93	-14.44	34.49	74.00	-39.51	Peak	VERTICAL
6	4075.00	47.74	-11.85	35.89	74.00	-38.11	Peak	VERTICAL

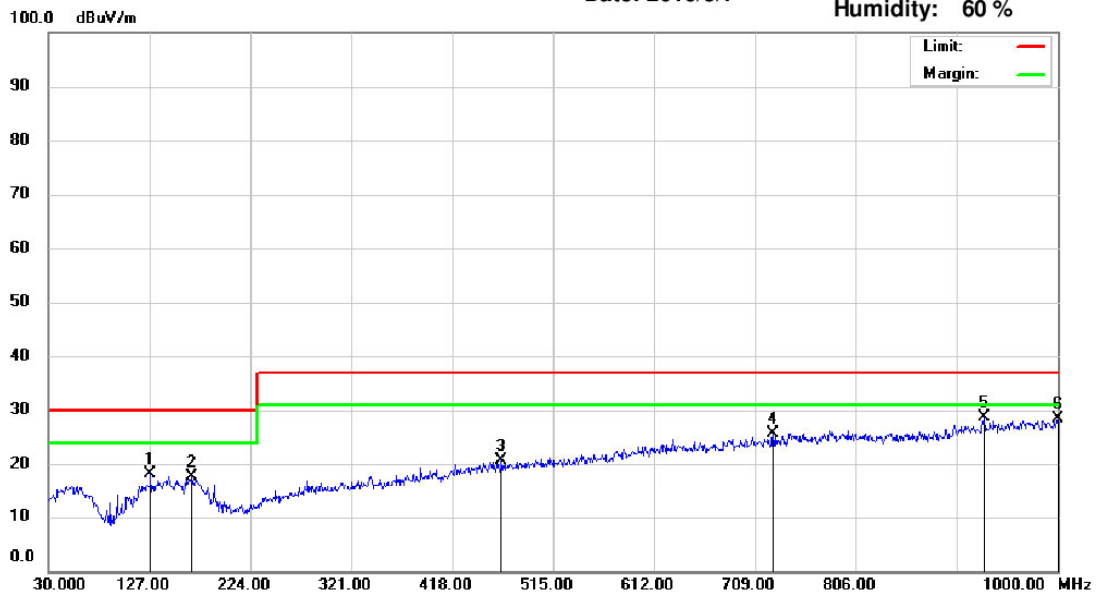
Operation Mode	Config 1	Test Date	2019/08/07
Test by	Jason	Pol	Horizontal



Address: No. 120, Lane 180, Hsin Ho Rd., Lung-Tan Dist.,  
Tao Yuan City 325, Taiwan.  
Tel: 03-4071718

Radiated Emission Measurement  
Date: 2019/8/7

Operator: James Kuo  
Temperature: 26 °C  
Humidity: 60 %



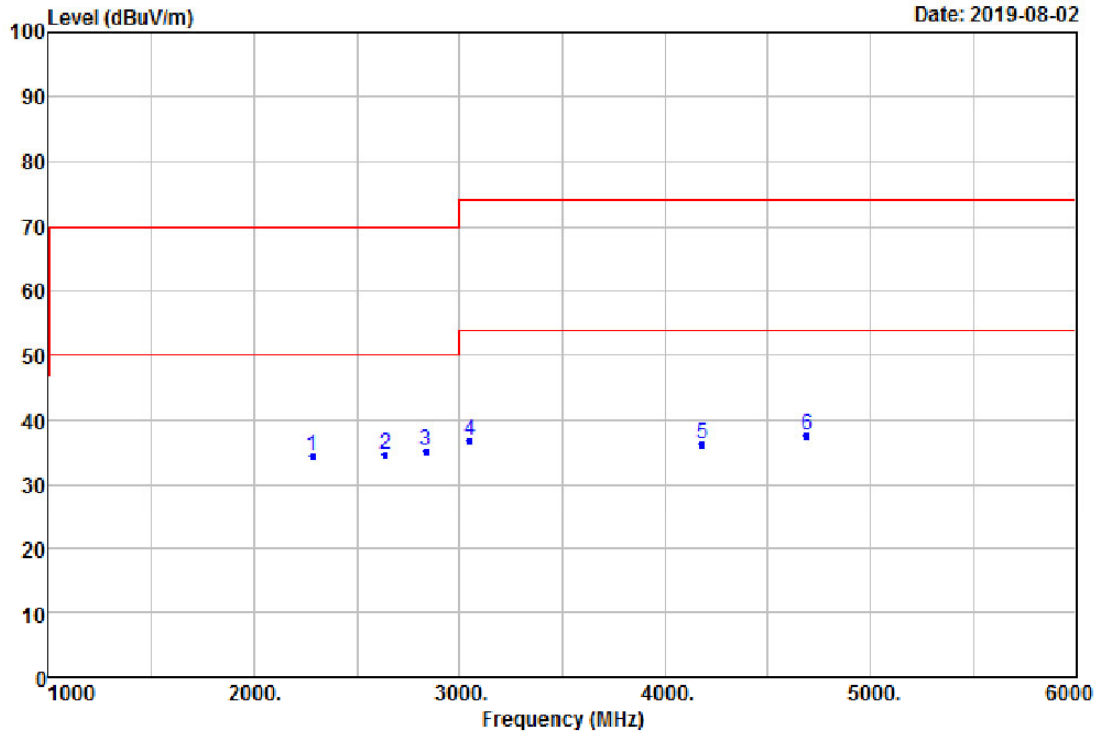
Site : Chamber 12

Polarization: *Horizontal*

Mk.	Frequency (MHz)	RX_R (dBuV)	Correct Factor(dB/m)	Emission (dBuV/m)	Limit (dBuV/m)	Margin (dB)	Ant.Pos (cm)	Tab.Pos (deg.)	Detector
1	127.97	35.89	-17.81	18.08	30.00	-11.92	200	111	peak
2	167.74	33.51	-15.94	17.57	30.00	-12.43	350	358	peak
3	465.53	30.87	-10.34	20.53	37.00	-16.47	127	0	peak
4	726.46	31.29	-5.73	25.56	37.00	-11.44	289	360	peak
5	929.19	31.91	-3.40	28.51	37.00	-8.49	200	134	peak
6	1000.00	30.58	-2.22	28.36	37.00	-8.64	398	330	peak



International Standard Laboratory Corp.  
Company Address: No. 120, Lane 180, Hsin Ho Rd.  
Lung-Tan Dist., Tao Yuan City 325, Taiwan  
Tel: (03)4071718 ; Fax: (03)4071738  
Web: www.isl.com.tw



Condition: 55022/32 B PK 3m HORIZONTAL  
Site : Chamber 19

Operator : jason

	Freq	Read Level	Factor	Level	Limit Line	Over Limit	Remark	Pol/Phase
	MHz	dBuV	dB/m	dBuV/m	dBuV/m	dB		
1	2285.00	50.15	-15.75	34.40	70.00	-35.60	Peak	HORIZONTAL
2	2640.00	50.21	-15.48	34.73	70.00	-35.27	Peak	HORIZONTAL
3	2835.00	50.48	-15.16	35.32	70.00	-34.68	Peak	HORIZONTAL
4	3050.00	51.41	-14.58	36.83	74.00	-37.17	Peak	HORIZONTAL
5	4180.00	47.92	-11.54	36.38	74.00	-37.62	Peak	HORIZONTAL
6	4690.00	47.41	-9.75	37.66	74.00	-36.34	Peak	HORIZONTAL

## 2.5 DC power input/output ports measurement.

### 2.5.1 Test Method:

Standard	Date	Description
EN 55032	2015+AC: 2016	Limits and methods of measurement of radio interference characteristics of information technology equipment.

Refer to section 8.3.2 of EN301489-1 for detail.

### 2.5.2 Limit:

Frequency range	Limit (quasi-peak) (dB $\mu$ V)	Limit (average) (dB $\mu$ V)
0,15 MHz to 0,5 MHz	66 to 56	56 to 46
> 0,5 MHz to 5 MHz	56	46
> 5 MHz to 30 MHz	60	50

NOTE: The limit decreases linearly with the logarithm of the frequency in the range 0,15 MHz to 0,50 MHz.

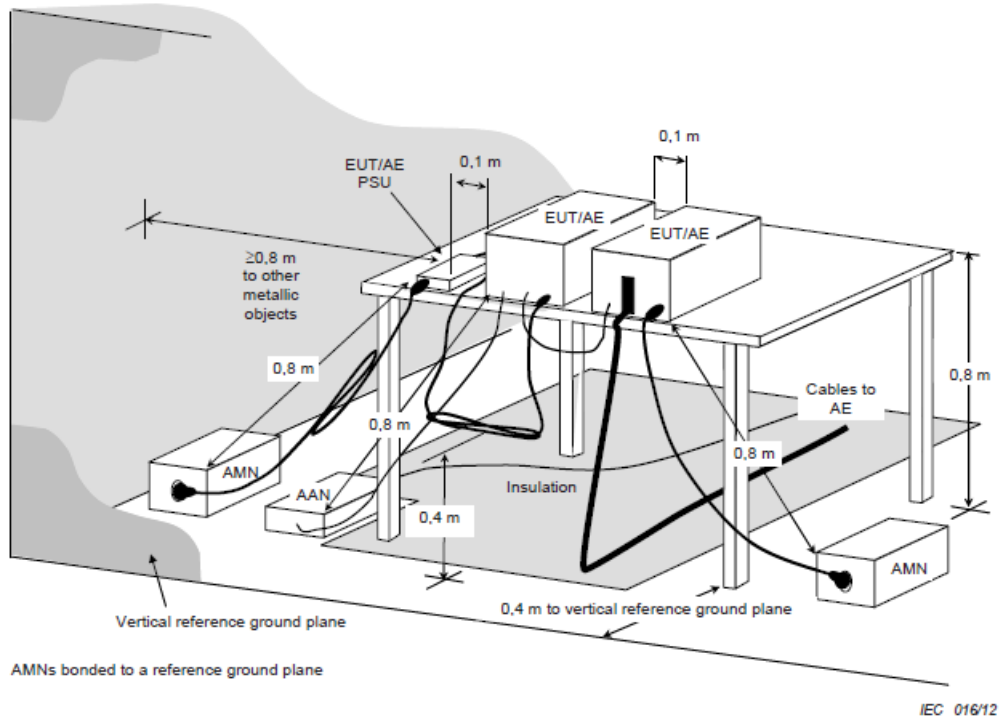
### 2.5.3 Test Procedure:

1. EUT was placed on an 0.8m wooden table above ground plane.
2. Set up EUT with support units and turn on the power of all equipment.
3. Link the EUT with Telecommunication tester, setup the test mode. The transmitter operating at continuously mode and max output rated power.
4. Maximum procedure was performed on the six highest emissions to ensure EUT compliance.
5. Repeat above procedures until all frequency measured were complete.

### 2.5.4 Test Instruments:

Refer to section 1.7 in this report

### 2.5.5 Test SET-UP (Block Diagram of Configuration)



### 2.5.6 Measurement Result:

N/A,



## **2.6 AC Mains power input/output ports measurement.**

### **2.6.1 Test Method:**

Standard	Date	Description
EN 55032	2015+AC:20 16	Limits and methods of measurement of radio interference characteristics of information technology equipment.

Refer to section 8.4.2 of EN301489-1 and 55032 Annex A for detail.

**2.6.2 Limit: Refer to 2.5.2**

**2.6.3 Test Procedure: Refer to 2.5.3**

**2.6.4 Test Instruments: Refer to 2.5.4**

**2.6.5 Conduction Emission Test Set-up: Refer to 2.5.5**

**2.6.6 Measurement Result:**

Refer to next page for details.

2.6.7 Measurement Data:

Operation Mode:	Config 1	Test Date:	2019/08/06
Test By:	Jason	Pol.:	L1

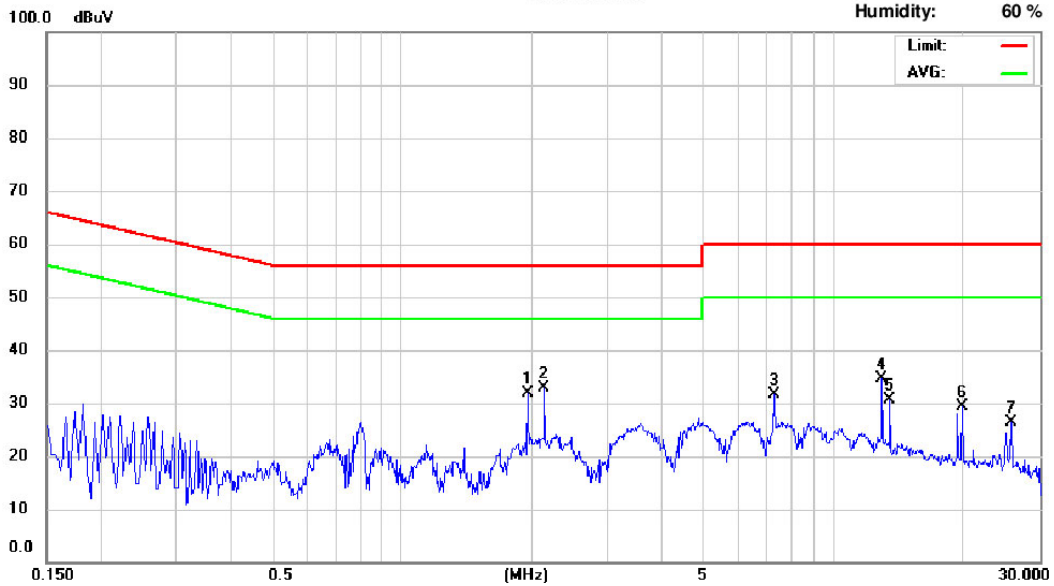


Address: No. 120, Lane 180, Hsin Ho Rd., Lung-Tan Dist.,  
Tao Yuan City 325, Taiwan.  
Tel: 03-4071718

Conducted Emission Measurement

Date: 2019/8/6

operator: Martin Lin  
Temperature: 26 °C  
Humidity: 60 %



Site: Conduction 03

Phase: L1

No.	Frequency (MHz)	QP_R (dBuV)	AVG_R (dBuV)	Correct Factor (dB)	QP Emission (dBuV)	QP Limit (dBuV)	QP Margin (dB)	AVG Emission (dBuV)	AVG Limit (dBuV)	AVG Margin (dB)
1	1.958	8.15	1.64	9.67	17.82	56.00	-38.18	11.31	46.00	-34.69
2	2.138	9.81	2.39	9.67	19.48	56.00	-36.52	12.06	46.00	-33.94
3	7.290	10.38	2.46	9.79	20.17	60.00	-39.83	12.25	50.00	-37.75
4	12.930	9.39	1.29	9.88	19.27	60.00	-40.73	11.17	50.00	-38.83
5	13.490	7.19	0.06	9.88	17.07	60.00	-42.93	9.94	50.00	-40.06
6	19.910	3.89	-1.92	9.95	13.84	60.00	-46.16	8.03	50.00	-41.97
7	25.730	4.14	-2.72	9.97	14.11	60.00	-45.89	7.25	50.00	-42.75

Operation Mode:	Config 1	Test Date:	2019/08/06
Test By:	Jason	Pol.:	N



Address: No. 120, Lane 180, Hsin Ho Rd., Lung-Tan Dist.,  
Tao Yuan City 325, Taiwan.  
Tel: 03-4071718

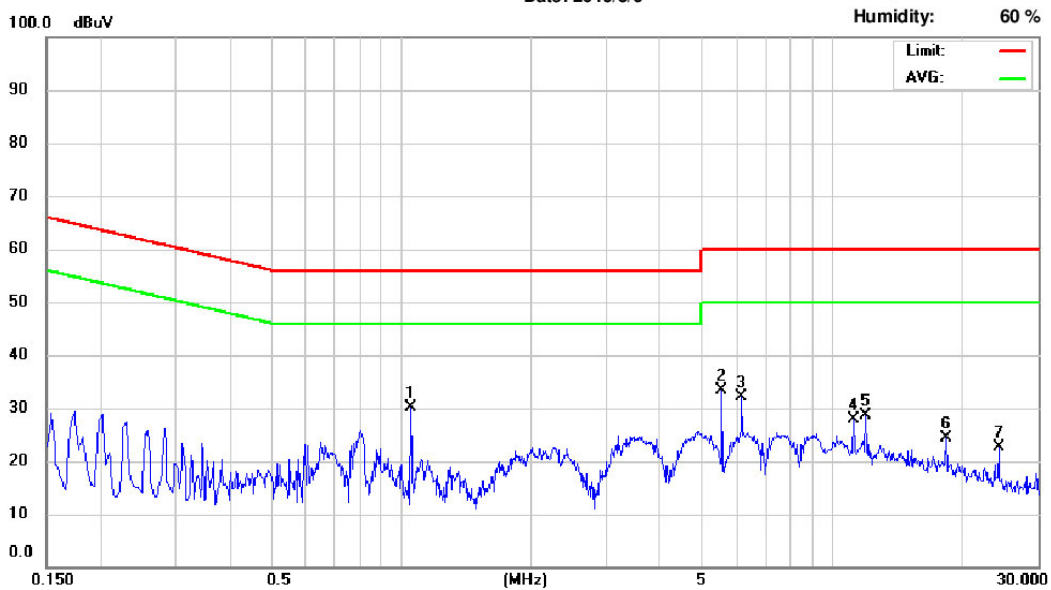
### Conducted Emission Measurement

Date: 2019/8/6

operator: Martin Lin

Temperature: 26 °C

Humidity: 60 %



Site: Conduction 03

Phase: N

No.	Frequency (MHz)	QP_R (dBuV)	AVG_R (dBuV)	Correct Factor (dB)	QP Emission (dBuV)	QP Limit (dBuV)	QP Margin (dB)	AVG Emission (dBuV)	AVG Limit (dBuV)	AVG Margin (dB)
1	1.054	1.72	-2.86	9.67	11.39	56.00	-44.61	6.81	46.00	-39.19
2	5.546	6.84	-3.22	9.79	16.63	60.00	-43.37	6.57	50.00	-43.43
3	6.162	11.30	3.68	9.80	21.10	60.00	-38.90	13.48	50.00	-36.52
4	11.234	6.44	-1.15	9.88	16.32	60.00	-43.68	8.73	50.00	-41.27
5	11.958	8.46	0.54	9.90	18.36	60.00	-41.64	10.44	50.00	-39.56
6	18.338	3.71	-2.20	9.99	13.70	60.00	-46.30	7.79	50.00	-42.21
7	24.310	0.79	-4.40	10.01	10.80	60.00	-49.20	5.61	50.00	-44.39

**2.7 Harmonic Current Emissions (AC mains input port) measurement. Refer to EN 301 489-1 Section 8.5**

**2.7.1 Test Method: Refer to 61000-3-2:2014 and IEC 61000-3-2:2014**

**2.7.2 Limit**

**Table 1 – Limits for Class A equipment**

Harmonic order n	Maximum permissible harmonic current A
<b>Odd harmonics</b>	
3	2,30
5	1,14
7	0,77
9	0,40
11	0,33
13	0,21
$15 \leq n \leq 39$	$0,15 \frac{15}{n}$
<b>Even harmonics</b>	
2	1,08
4	0,43
6	0,30
$8 \leq n \leq 40$	$0,23 \frac{8}{n}$

**Note :**For Class B equipment, the harmonics of the input current shall not exceed the values given in table 1 multiplied by a factor of 1,5.

**Table 2 – Limits for Class C equipment**

Harmonic order n	Maximum permissible harmonic current expressed as a percentage of the input current at the fundamental frequency %
2	2
3	$30 \cdot \lambda^*$
5	10
7	7
9	5
$11 \leq n \leq 39$ (odd harmonics only)	3

\*  $\lambda$  is the circuit power factor

**Table 3 – Limits for Class D equipment**

Harmonic order n	Maximum permissible harmonic current per watt mA/W	Maximum permissible harmonic current A
3	3,4	2,30
5	1,9	1,14
7	1,0	0,77
9	0,5	0,40
11	0,35	0,33
$13 \leq n \leq 39$ (odd harmonics only)	$\frac{3,85}{n}$	See Table 1

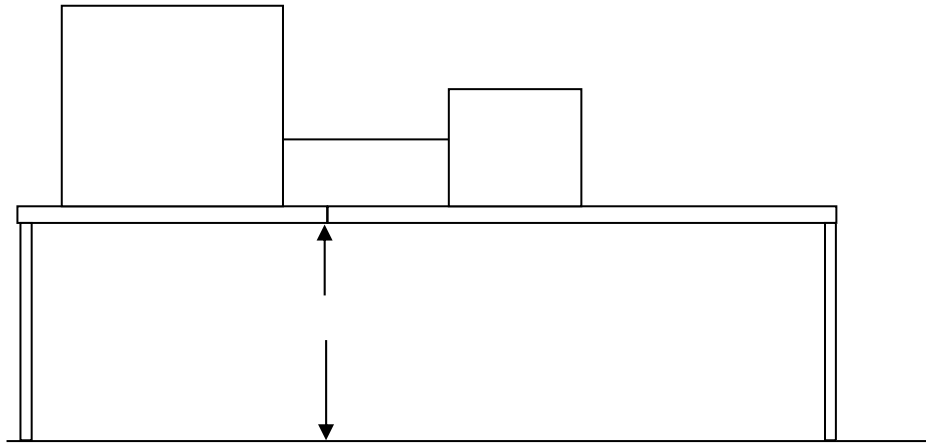
### 2.7.3 Test Procedure:

The EUT was placed on the top of a wooden table 0.8 meters above the ground and operated to produce the maximum harmonic components under normal operating conditions for each successive harmonic component in turn.

### 2.7.4 Test Instruments:

Refer to section 1.7 in this report

### 2.7.5 Test Set-up



### 2.7.6 Measurement Result:

N/A

**2.8 Voltage Fluctuations and Flicker (AC mains input port) measurement. Refer to EN 301 489-1 Section 8.6**

**2.8.1 Test Method: Refer to EN 61000-3-3:2013 and IEC 61000-3-3:2013**

**2.8.2 Limit**

TEST ITEM	LIMIT
$P_{st}$	1.0
$P_{lt}$	0.65
$D(t)(ms)$	500ms
$d_{max} (%)$	4%
dc (%)	3.3%

**2.8.3 Test Procedure:**

The EUT was placed on the top of a wooden table 0.8 meters above the ground and operated to produce the most unfavorable sequence of voltage changes under normal operating conditions.

**2.8.4 Test Instruments:**

Refer to section 1.7 in this report

**2.8.5 Test Set-up**

Refer to 2.7.5

**2.8.6 Measurement Result: N/A**

**2.9 Telecommunication Port measurement. Refer to EN 301 489-1 Section 8.7**

**2.9.1 Test Method:**

Standard	Date	Description
EN 55032	2015+AC:20 16	Limits and methods of measurement of radio interference characteristics of information technology equipment.

Refer to section 8.7.2 of EN301489-1 for detail.

**2.9.2 Limit: Limits for conducted emissions from telecommunication ports**

Frequency range	Voltage limits		Current limits	
	Quasi-peak	Average	Quasi-peak	Average
0.15 MHz to 0.5 MHz	84 dB $\mu$ V to 74 dB $\mu$ V	74 dB $\mu$ V to 64 dB $\mu$ V	40 dB $\mu$ A to 30 dB $\mu$ A	30 dB $\mu$ A to 20 dB $\mu$ A
0.5 MHz to 30 MHz	74 dB $\mu$ V	64 dB $\mu$ V	30 dB $\mu$ A	20 dB $\mu$ A
NOTE 1: The limits decrease linearly with the logarithm of the frequency in the range 0.15 MHz to 0.5 MHz.				
NOTE 2: The current and voltage disturbance limits are derived for use with an Impedance Stabilization Network (ISN) which presents a common mode (asymmetric mode) impedance of 150 $\Omega$ to the telecommunication port under test (conversion factor is $20 \log_{10} 150/I = 44\text{dB}$ )				
NOTE 3: The emission requirement only applies to telecommunication ports as specified in EN 55032 . The provisional relaxation of 10 dB will be reviewed no later than 3 years after the date of withdrawal based on the results and interference cases seen in this period. Wherever possible it is recommended to comply with the limits without the provisional relaxation.				

**2.9.3 Test Procedure: Refer to EN 55032**

**2.9.4 Test Instruments: Refer to 2.5.4**

**2.9.5 Conduction Emission Test Set-up: Refer to 2.5.5**

**2.9.6 Measurement Result: N/A**



# 3.IMMUNITY

EN 301 489-17

EN55024

## 3.1 Test Configuration:

Refer to EN 301 489-1, Section 9.1.

## 3.2 Special Conditions:

**EN301489-17**

No special conditions shall apply to UE in the scope of the present document.

## 3.3 Summary of Test Results:

Test Items	Reference Section	Result
Electrostatic discharge	EN 301 489-1 Section 9.3 EN 55024 Section 4.2.1	PASS
Radio frequency electromagnetic field (80 to 1000MHz and 1000MHz to 6000MHz)	EN 301 489-1 Section 9.2 EN 55024 Section 4.2.3.1	PASS
Fast transients, common mode	EN 301 489-1 Section 9.4 EN 55024 Section 4.2.2	N/A
Surges	EN 301 489-1 Section 9.8 EN 55024 Section 4.2.5	N/A
Radio Frequency, common mode	EN 301 489-1 Section 9.5 EN 55024 Section 4.2.3.2	N/A
Voltage Dips and interruptions	EN 301 489-1 Section 9.7	N/A
Transients and surges in the vehicular environment	EN 301 489-1 Section 9.6	N/A
Power Frequency Magnetic (PMF)	EN 55024 Section 4.2.4	N/A

### 3.4 Performance Criteria Description:

#### 3.4.1 EN301 489-17

The performance criteria are:

- performance criteria A for immunity tests with phenomena of a continuous nature;
- performance criteria B for immunity tests with phenomena of a transient nature;
- performance criteria C for immunity tests with power interruptions exceeding a certain time.

The equipment shall meet the minimum performance criteria as specified in the following table.

Criteria	During test	After test (i.e. as a result of the application of the test)
A	<ul style="list-style-type: none"> <li>• Shall operate as intended. (See note).</li> <li>• Shall be no loss of function.</li> <li>• Shall be no unintentional transmissions.</li> </ul>	<ul style="list-style-type: none"> <li>• Shall operate as intended.</li> <li>• Shall be no degradation of performance.</li> <li>• Shall be no loss of function.</li> <li>• Shall be no loss of critical stored data.</li> </ul>
B	<ul style="list-style-type: none"> <li>• May be loss of function.</li> </ul>	<ul style="list-style-type: none"> <li>• Functions shall be self-recoverable.</li> <li>• Shall operate as intended after recovering.</li> <li>• Shall be no loss of critical stored data.</li> </ul>
C	<ul style="list-style-type: none"> <li>• May be loss of function.</li> </ul>	<ul style="list-style-type: none"> <li>• Functions shall be recoverable by the operator.</li> <li>• Shall operate as intended after recovering.</li> <li>• Shall be no loss of critical stored data.</li> </ul>
NOTE	<p>Operate as intended during the test allows a level of degradation:</p> <p>Minimum performance level:</p> <ul style="list-style-type: none"> <li>• For equipment that supports a PER or FER, the minimum performance level shall be a PER or FER less than or equal to 10 %.</li> <li>• For equipment that does not support a PER or a FER, the minimum performance level shall be no loss of the wireless transmission function needed for the intended use of the equipment.</li> </ul>	

**Performance criteria for Continuous phenomena**

The performance criteria A shall apply.

Where the EUT is a transmitter in standby mode, unintentional transmission shall not occur during the test.

**Performance criteria for Transient phenomena**

The performance criteria B shall apply, except for voltage dips greater than or equal to 100 ms and voltage interruptions of 5000 ms duration, for which performance criteria C shall apply.

Where the EUT is a transmitter in standby mode, unintentional transmission shall not occur as a result of the application of the test.

## **EN55024**

### **Performance criterion A**

The equipment shall continue to operate as intended without operator intervention. No degradation of performance or loss of function is allowed below a performance level specified by the manufacturer when the equipment is used as intended. The performance level may be replaced by a permissible loss of performance. If the minimum performance level or the permissible performance loss is not specified by the manufacturer, then either of these may be derived from the product description and documentation, and by what the user may reasonably expect from the equipment if used as intended.

### **Performance criterion B**

After the test, the equipment shall continue to operate as intended without operator intervention. No degradation of performance or loss of function is allowed, after the application of the phenomena below a performance level specified by the manufacturer, when the equipment is used as intended. The performance level may be replaced by a permissible loss of performance. During the test, degradation of performance is allowed. However, no change of operating state or stored data is allowed to persist after the test. If the minimum performance level (or the permissible performance loss) is not specified by the manufacturer, then either of these may be derived from the product description and documentation, and by what the user may reasonably expect from the equipment if used as intended.

### **Performance criterion C**

Loss of function is allowed, provided the function is self-recoverable, or can be restored by the operation of the controls by the user in accordance with the manufacturer's instructions. Functions, and/or information stored in non-volatile memory, or protected by a battery backup, shall not be lost.

### 3.5 Electrostatic Discharge Measurement. Refer to EN 301 489-1 Section 9.3

#### 3.5.1 Test Method and Procedure:

EN61000-4-2 and EN 301 489-1 Section 9.3.2.

#### 3.5.2 Performance criteria:

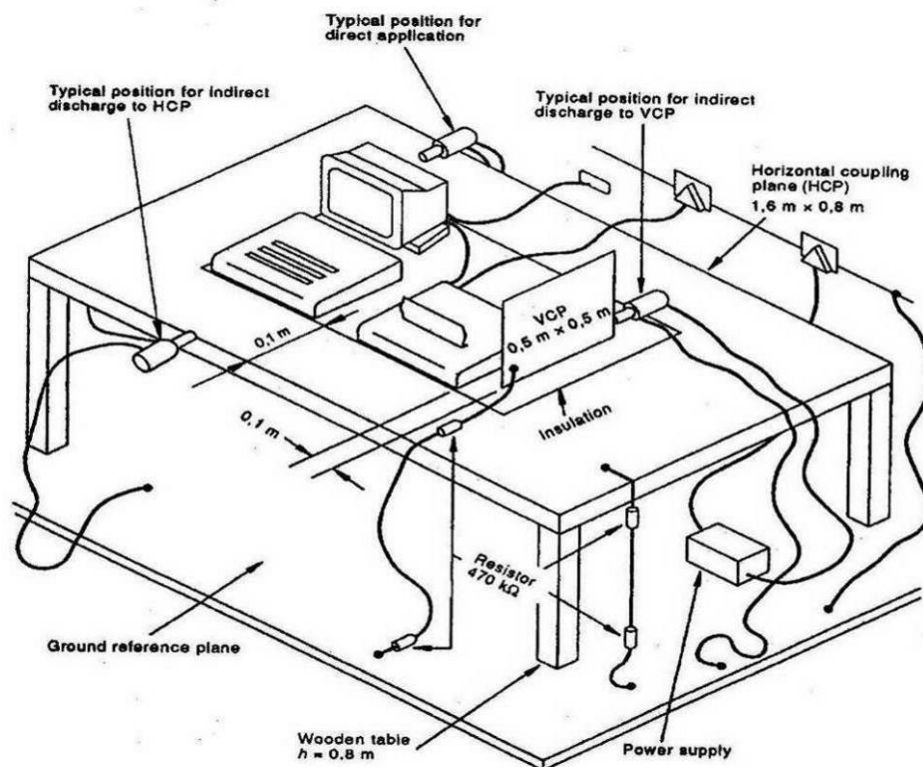
Refer to EN 301 489-1 Section 9.3.3.

Refer to EN 55024 Section 8

#### 3.5.3 Test Instruments:

Refer to section 1.7 in this report

#### 3.5.4 Test SET-UP (Block Diagram of Configuration)



### 3.5.5 Measurement Result:

Operation Mode:	Config 1,2,3,4	Test Date:	2019/8/13
Temperature:	24 °C	Humidity:	45%
		Test By:	Jason

Basic Standard : EN61000-4-2  
 Discharge Impedance : 330 ohm / 150 pF  
 Discharge Voltage : Air Discharge: +/- 2 ~ 8 kV  
                                 Contact Discharge: +/- 2 ~ 4 kV  
                                 VCP/HCP: +/- 2 ~ 4 kV  
 Polarity : Positive/Negative  
 Number of Discharge : Minimum 10/50 times at each test point  
 Discharge Mode : Single Discharge  
 Discharge Period : 1 second minimum

Note 1: For contact discharge, the EUT shall be exposed to at least 50 discharges, 25 each at negative and positive polarity. For air discharge, A minimum of 10 single air discharges shall be applied

Note 2: Test point refer to test report Appendix 1

Air Discharge							
Test Levels						Results	
±2kV	Performance Criterion	±4kV	Performance Criterion	± 8kV	Performance Criterion	Pass	Fail
<input type="checkbox"/>	<input type="checkbox"/> A <input type="checkbox"/> B <input type="checkbox"/> C	<input type="checkbox"/>	<input type="checkbox"/> A <input type="checkbox"/> B <input type="checkbox"/> C	<input type="checkbox"/>	<input type="checkbox"/> A <input type="checkbox"/> B <input type="checkbox"/> C	<input type="checkbox"/>	<input type="checkbox"/>

Contact Discharge							
Test Levels						Results	
±2kV	Performance Criterion	±4kV	Performance Criterion	± 6kV	Performance Criterion	Pass	Fail
<input checked="" type="checkbox"/>	<input checked="" type="checkbox"/> A <input type="checkbox"/> B <input type="checkbox"/> C	<input checked="" type="checkbox"/>	<input checked="" type="checkbox"/> A <input type="checkbox"/> B <input type="checkbox"/> C	<input type="checkbox"/>	<input type="checkbox"/> A <input type="checkbox"/> B <input type="checkbox"/> C	<input checked="" type="checkbox"/>	<input type="checkbox"/>

Discharge To VCP							
Test Levels						Results	
±2kV	Performance Criterion	±4kV	Performance Criterion	± 6kV	Performance Criterion	Pass	Fail
<input checked="" type="checkbox"/>	<input checked="" type="checkbox"/> A <input type="checkbox"/> B <input type="checkbox"/> C	<input checked="" type="checkbox"/>	<input checked="" type="checkbox"/> A <input type="checkbox"/> B <input type="checkbox"/> C	<input type="checkbox"/>	<input type="checkbox"/> A <input type="checkbox"/> B <input type="checkbox"/> C	<input checked="" type="checkbox"/>	<input type="checkbox"/>

Discharge To HCP							
Test Levels						Results	
±2kV	Performance Criterion	±4kV	Performance Criterion	± 6kV	Performance Criterion	Pass	Fail
<input checked="" type="checkbox"/>	<input checked="" type="checkbox"/> A <input type="checkbox"/> B <input type="checkbox"/> C	<input checked="" type="checkbox"/>	<input checked="" type="checkbox"/> A <input type="checkbox"/> B <input type="checkbox"/> C	<input type="checkbox"/>	<input type="checkbox"/> A <input type="checkbox"/> B <input type="checkbox"/> C	<input checked="" type="checkbox"/>	<input type="checkbox"/>

**Remark:**

A: No degradation in the performance of the EUT was observed.

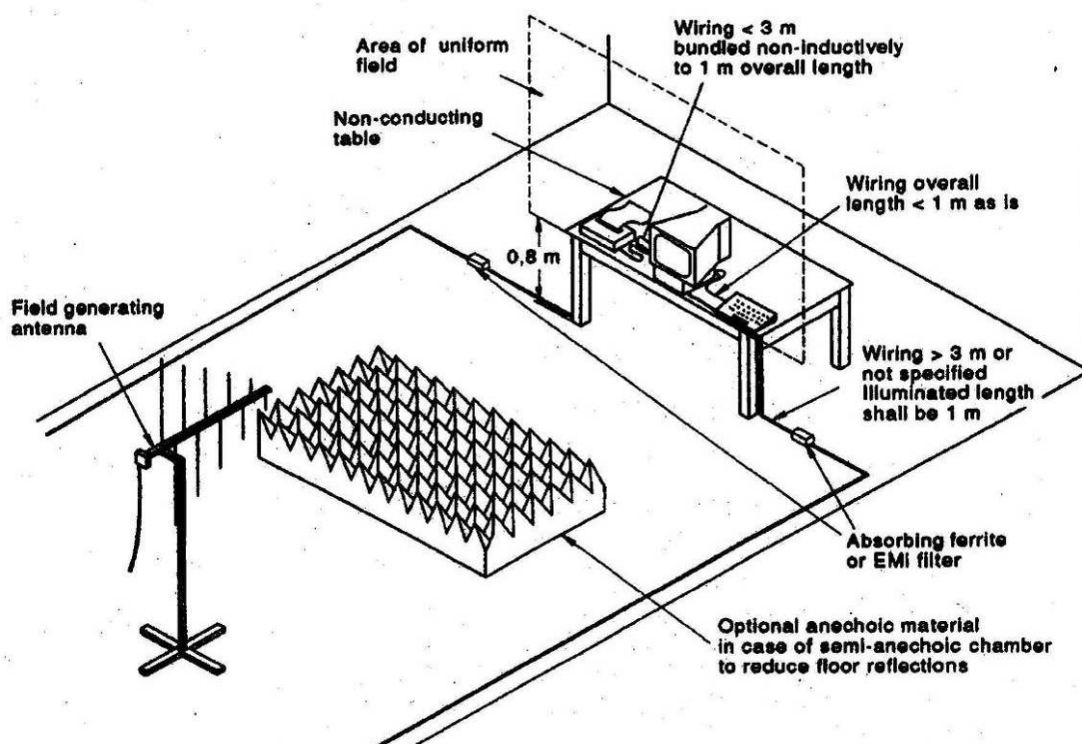
### 3.6 Radio Frequency Electromagnetic Field (80MHz to 6GHz) Measurement. Refer to EN 301 489-1 Section 9.2

3.6.1 **Test Method and Procedure:**  
EN61000-4-3 and EN 301 489-1 Section 9.2.2.

3.6.2 **Performance criteria:**  
Refer to EN 301 489-1 Section 9.2.3.

3.6.3 **Test Instruments:**  
Refer to section 1.7 in this report

### 3.6.4 Test SET-UP (Block Diagram of Configuration): Test setup:



3.6.5 **Measurement Result:**  
Refer to below for results.



### 3.6.6 Measurement Data:

Operation Mode:	Config 1,2,3,4	Test Date:	2019/8/12
Temperature:	25 °C	Humidity:	50 %
		Test By:	Jason

Basic Standard : EN61000-4-3  
 Frequency range : 80 to 1000MHz and 1000 to 6000 MHz  
 Field strength : 3 V/m  
 Modulation : AM 80%, 1 kHz Sinewave  
 Frequency step : 1 % of fundamental  
 Polarity of Antenna : Horizontal and Vertical  
 Test distance : 3 m (EUT to antenna reference point)

No.	Frequency (MHz)	Antenna Orientation	Observation	EUT Orientation
1	80 - 6000	Vertical/Horizontal	CT, CR and A, the EUT to be continuously received with no timeouts	0 degree
2	80 - 6000	Vertical/Horizontal		90 degree
3	80 - 6000	Vertical/Horizontal		180 degree
4	80 - 6000	Vertical/Horizontal		270 degree

**Remark:**

A : No degradation in the performance of the EUT was observed.  
 N/A : Not Applicable.

**3.7 Fast Transients, Common Mode Measurement. Refer to EN 301 489-1 Section 9.4**

**3.7.1 Test Method and Procedure:**

EN61000-4-4: 2012, and EN 301 489-1 Section 9.4.2.

**3.7.2 Performance criteria:**

Refer to EN 301 489-1 Section 9.4.3.

**3.7.3 Test Instruments**

Refer to section 1.7 in this report

**3.7.4 Test SET-UP (Block Diagram of Configuration):**

Refer to Appendix 2 setup photo

**3.7.5 Measurement Result:**

N/A

**3.8 Surges Measurement. Refer to EN 301 489-1 Section 9.8**

**3.8.1 Test Method and Procedure:**

EN61000-4-5: 2014, and EN 301 489-1 Section 9.8.2.

**3.8.2 Performance criteria:**

Refer to EN 301 489-1 Section 9.8.3.

Refer to EN 55024 Section 8

**3.8.3 Test Instruments:**

Refer to section 1.7 in this report

**3.8.4 Test SET-UP (Block Diagram of Configuration):**

Refer to Appendix 2 setup photo

**3.8.5 Measurement Result:**

N/A

**3.9 Radio Frequency, Common Mode Measurement. Refer to EN 301 489-1 Section 9.5**

**3.9.1 Test Method and Procedure:**

EN61000-4-6: 2014+AC:2015, and EN 301 489-1 Section 9.5.2.

**3.9.2 Performance criteria:**

Refer to EN 301 489-1 Section 9.5.3.

**3.9.3 Test Instruments:**

Refer to section 1.7 in this report

**3.9.4 Test SET-UP (Block Diagram of Configuration):**

Refer to Appendix 2 setup photo

**3.9.5 Measurement Result:**

N/A

### 3.10 Transients and surges in the vehicular environment measurement. Refer to EN 301 489-1 Section 9.6

#### 3.10.1 Test Method and Procedure:

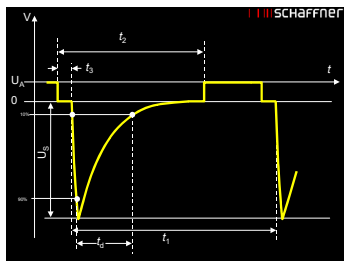
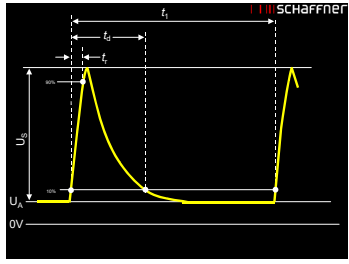
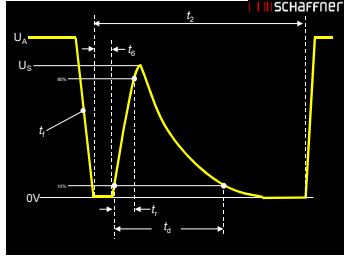
Refer to ISO 7637-2 for 12Vdc and 24Vdc equipment. , and EN 301 489-1 Section 9.6.2.

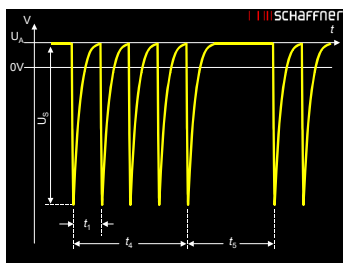
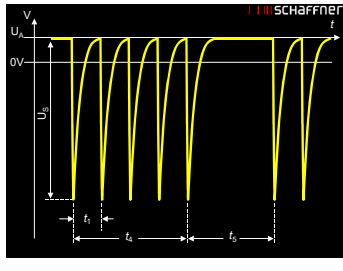
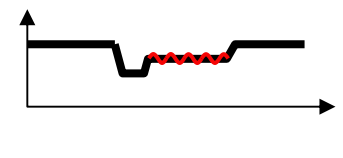
#### 3.10.2 Performance criteria:

Refer to EN 301 489-1 Section 9.6.3.

#### 3.10.3 Test Instruments:

Refer to section 1.7 in this report

Pulse	Us/Vs	Ri	Test parameters	Delay	Figure
ISO 7637-2 (2004) – Pulse 1	-450V	50.0 Ohm	td = 1.0ms, t1 = 2.5s, t2 = 200.0m	0.0 s	
ISO 7637-2 (2004) – Pulse 2A	37.5V	2.0 Ohm	td = 50.0us, t1 = 3.0s	0.0 s	
ISO 7637-2 (2004) – Pulse 2B	20.0V	0.0 Ohm	td = 1.0s	60.0 s	

ISO 7637-2 (2004) – Pulse 3A	-150V	50.0 Ohm	t1 = 100.0us, t4 = 10.0ms, t5 = 90.0ms	0.0 s	
ISO 7637-2 (2004) – Pulse 3B	150V	50.0 Ohm	t1 = 100.0us, t4 = 10.0ms, t5 = 90.0ms	0.0 s	
ISO 7637-2 (2004) – Pulse 4	-12V	0.0 Ohm	Ua = -5.0V, t7 = 70.0ms, t8 = 30.0ms, t9 = 10.0s, t10 = 10.0ms, t11 = 50.0ms	60.0 s	

### 3.10.4 Test SET-UP (Block Diagram of Configuration):

Refer to Appendix 2 setup photo.

### 3.10.5 Measurement Result:

N/A.

**3.11 Voltage Dips and Interruptions Measurement. Refer to EN 301 489-1 Section 9.7**

**3.11.1 Test Method and Procedure:**

EN61000-4-11: 2004, and EN 301 489-1 Section 9.7.2.

**3.11.2 Performance criteria:**

Refer to EN 301 489-1 Section 9.7.3.

Refer to EN 55024 Section 8

**3.11.3 Test Instruments**

Refer to section 1.7 in this report

**3.11.4 Test SET-UP:**

Refer to Appendix 2 setup photo

**3.11.5 Measurement Result:**

N/A

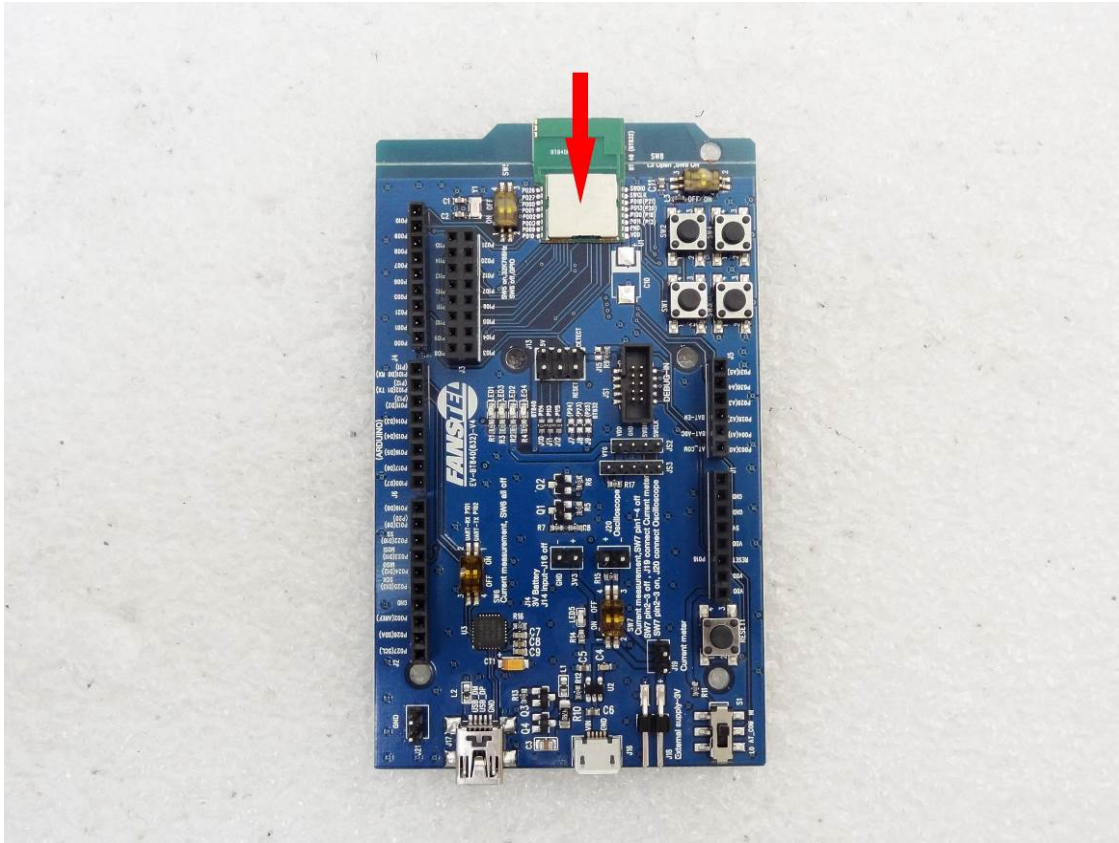
# APPENDIX 1

## ESD TEST POINT

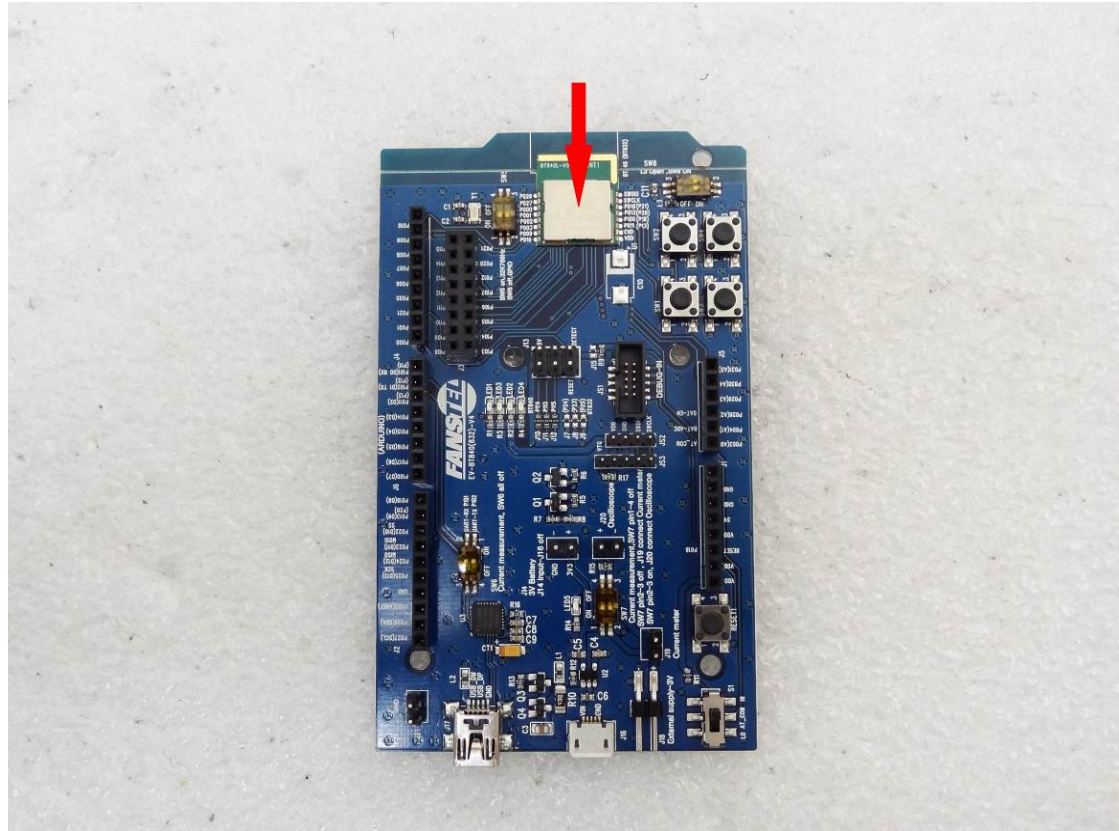




*Photo 3*



*Photo 4*

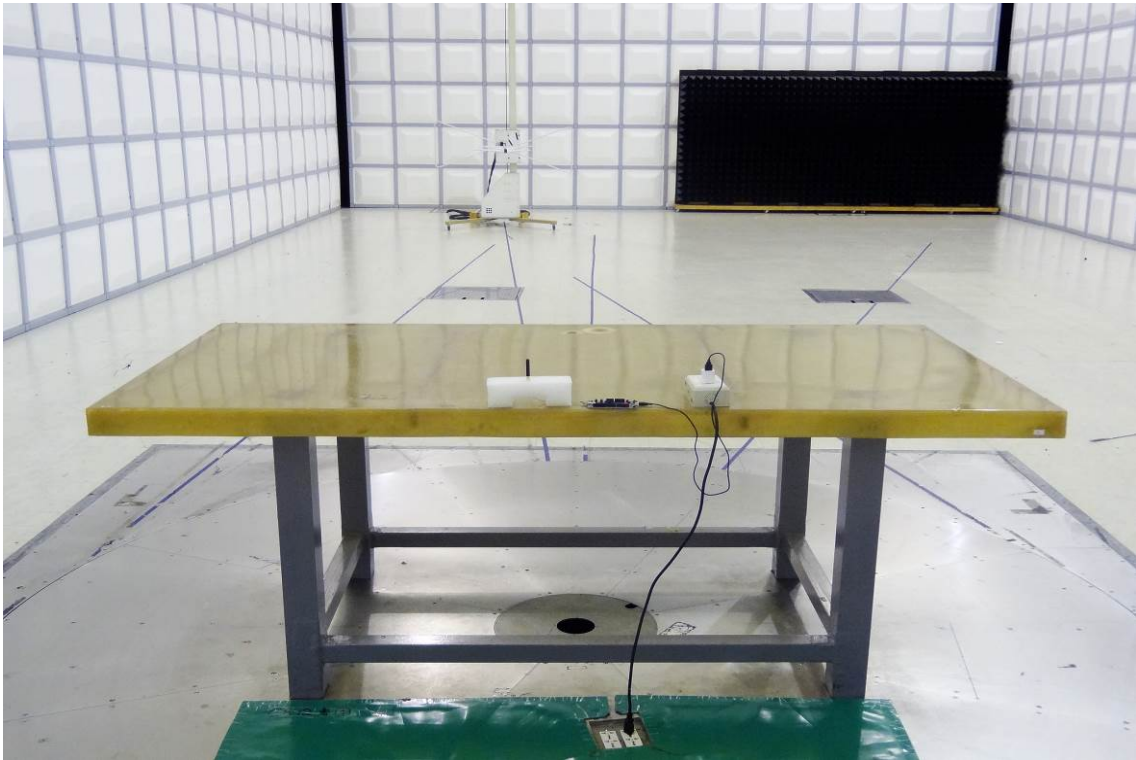


## **APPENDIX 2**

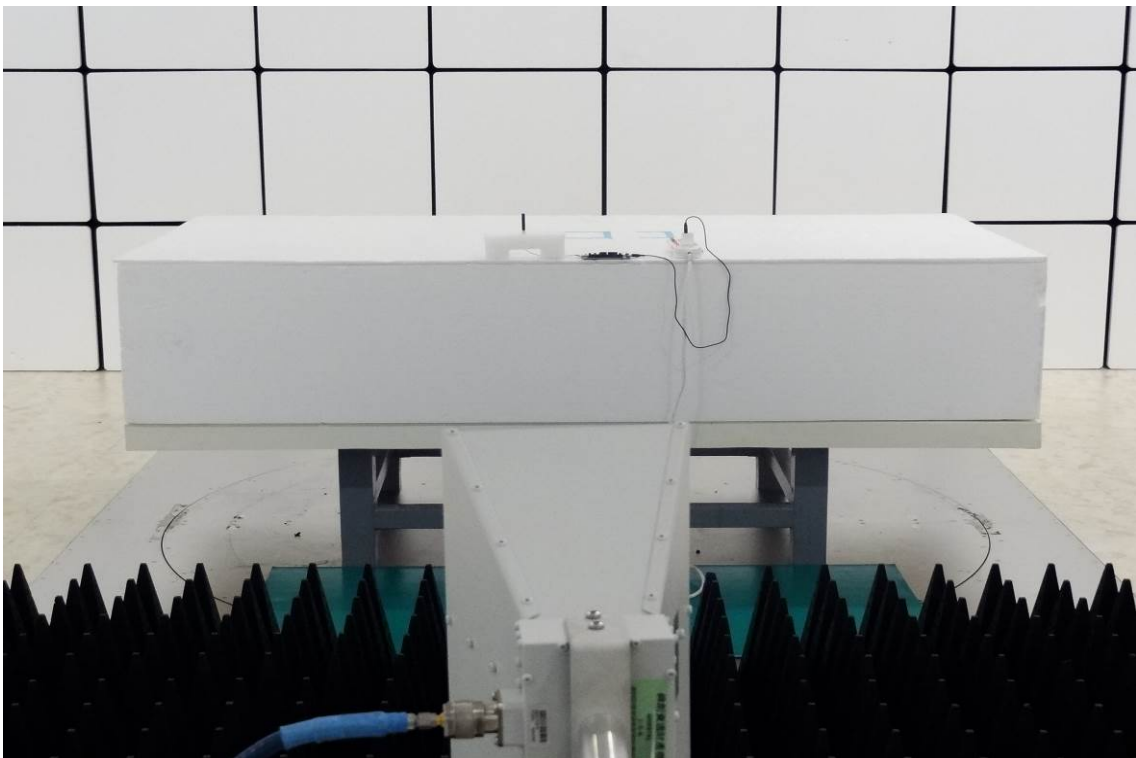
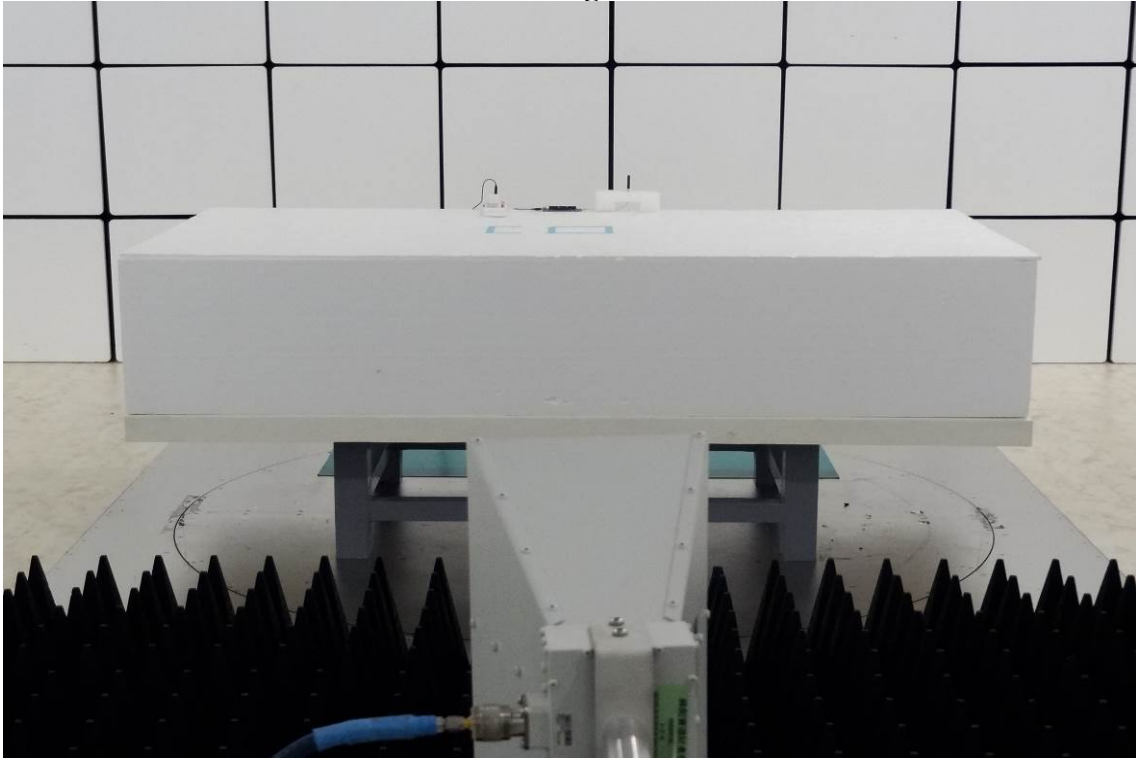
# **PHOTOGRAPHS OF TEST SETUP**

**RADIATED EMISSION TEST**

**Config. 1-4**

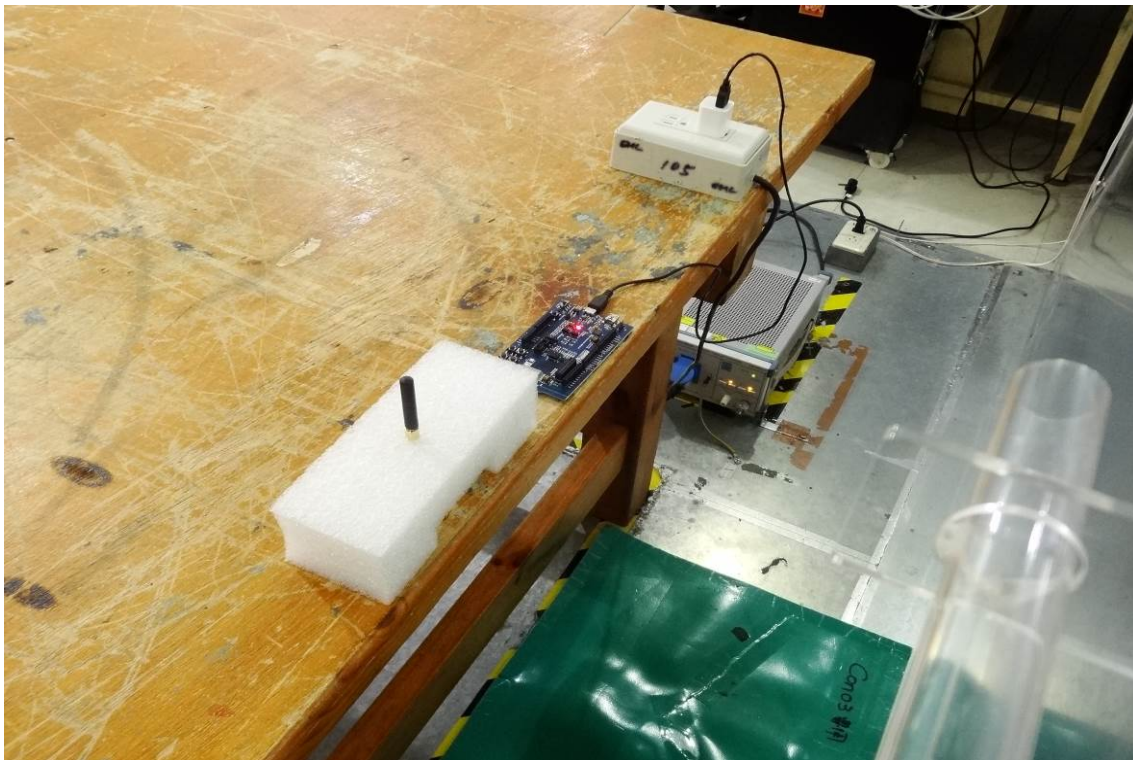


**Config 1-4**



## AC POWER LINE CONDUCTED EMISSION TEST

### Config 1-4



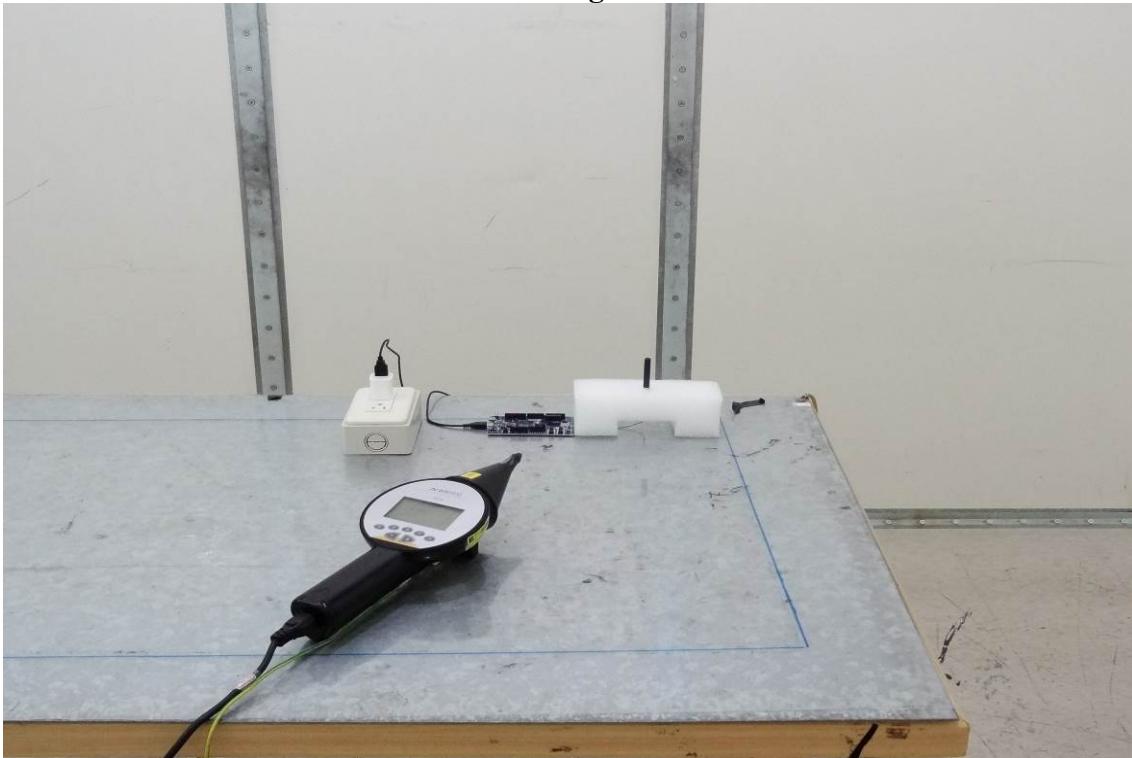
**ELECTROSTATIC DISCHARGE TEST (EN 61000-4-2)**

**Config 1**



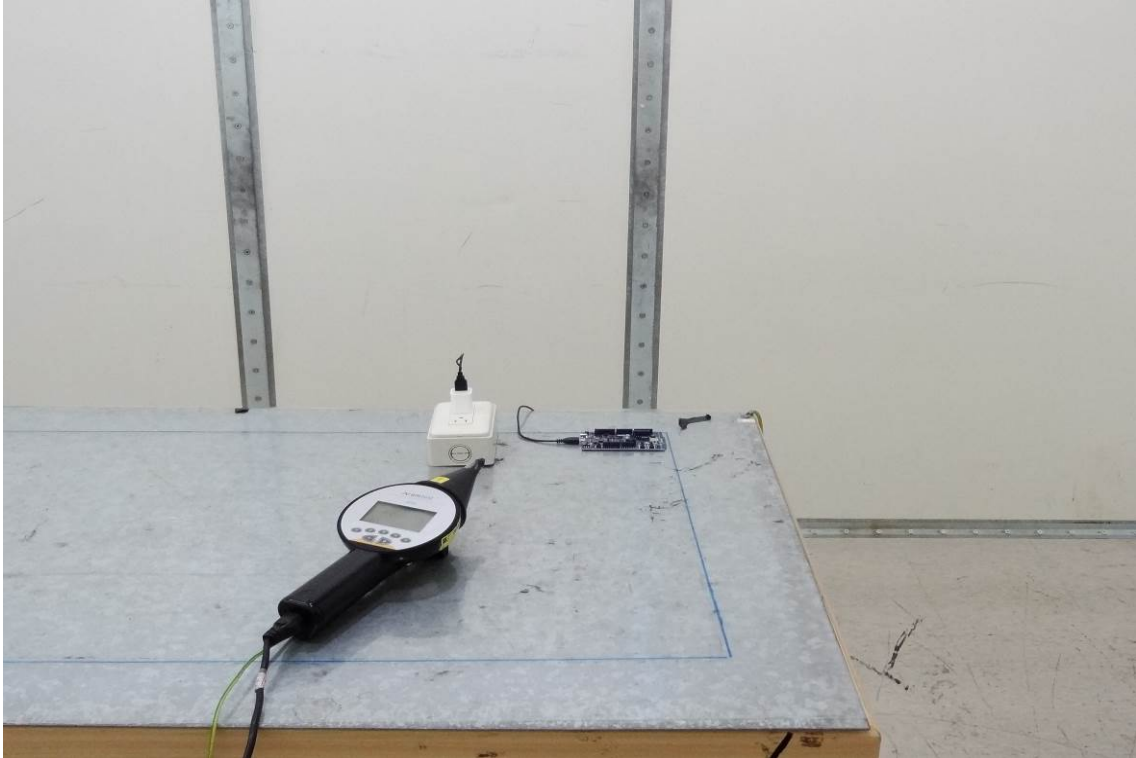
**ELECTROSTATIC DISCHARGE TEST (EN 61000-4-2)**

**Config 2**



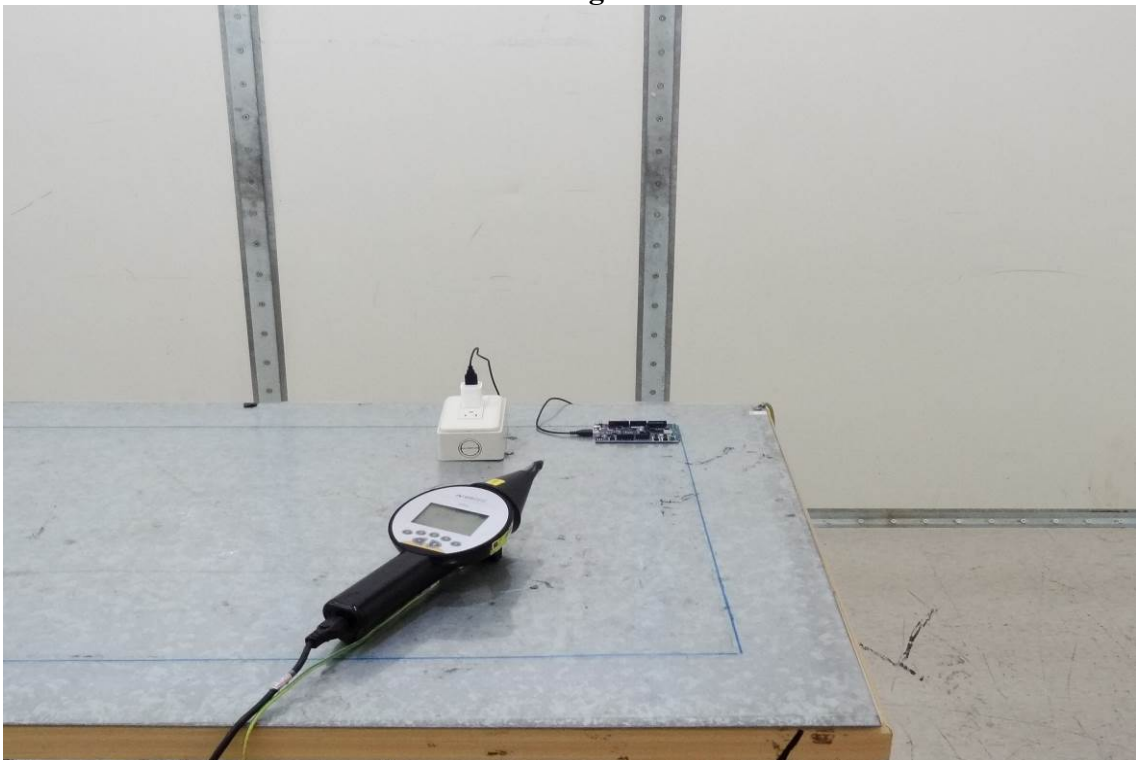
**ELECTROSTATIC DISCHARGE TEST (EN 61000-4-2)**

**Config 3**



**ELECTROSTATIC DISCHARGE TEST (EN 61000-4-2)**

**Config 4**





**RADIATED ELECTROMAGNETIC FIELD (EN 61000-4-3)**

**Config 1**



**RADIATED ELECTROMAGNETIC FIELD (EN 61000-4-3)**

**Config 2**



**RADIATED ELECTROMAGNETIC FIELD (EN 61000-4-3)**

**Config 3**



**RADIATED ELECTROMAGNETIC FIELD (EN 61000-4-3)**

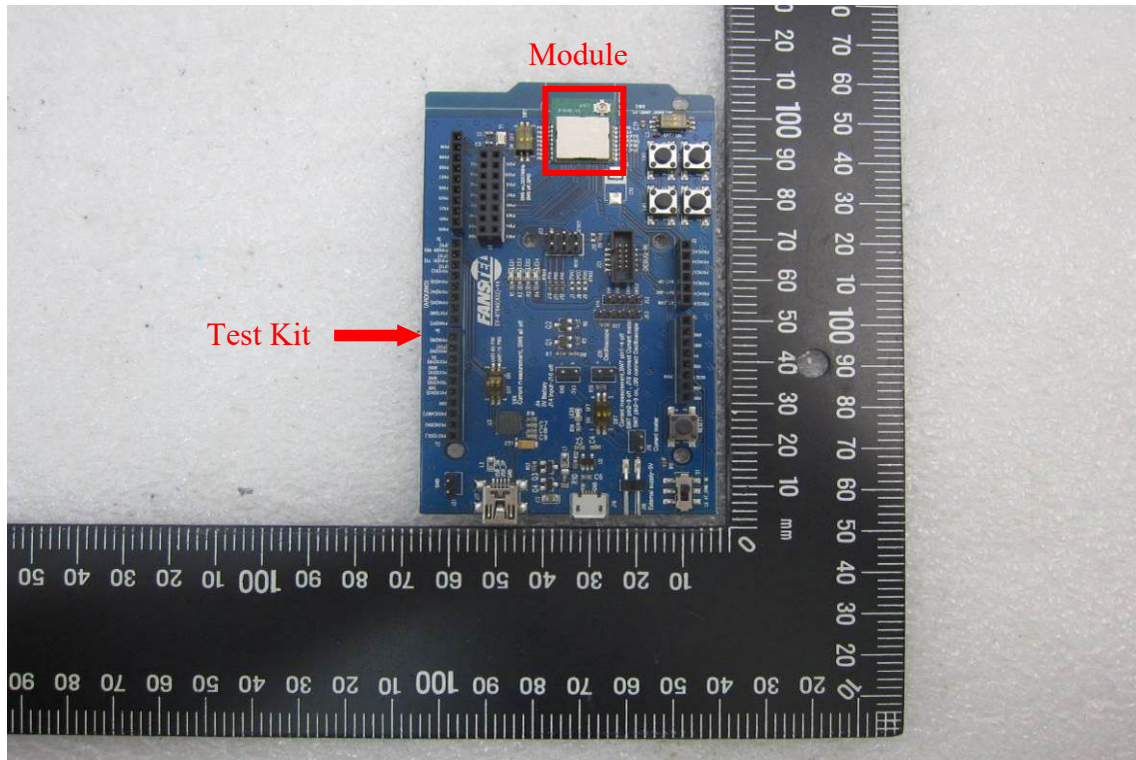
**Config 4**



## **APPENDIX 3**

# **PHOTOGRAPHS OF EUT**

*EUT 1*

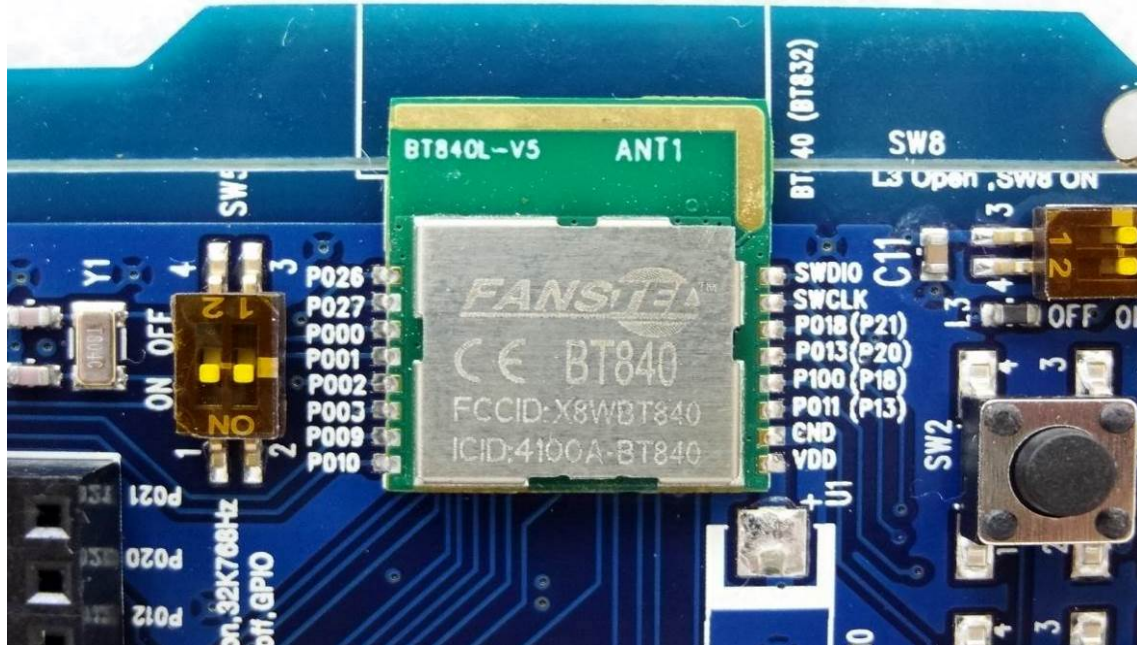


*EUT 2 BT840E*

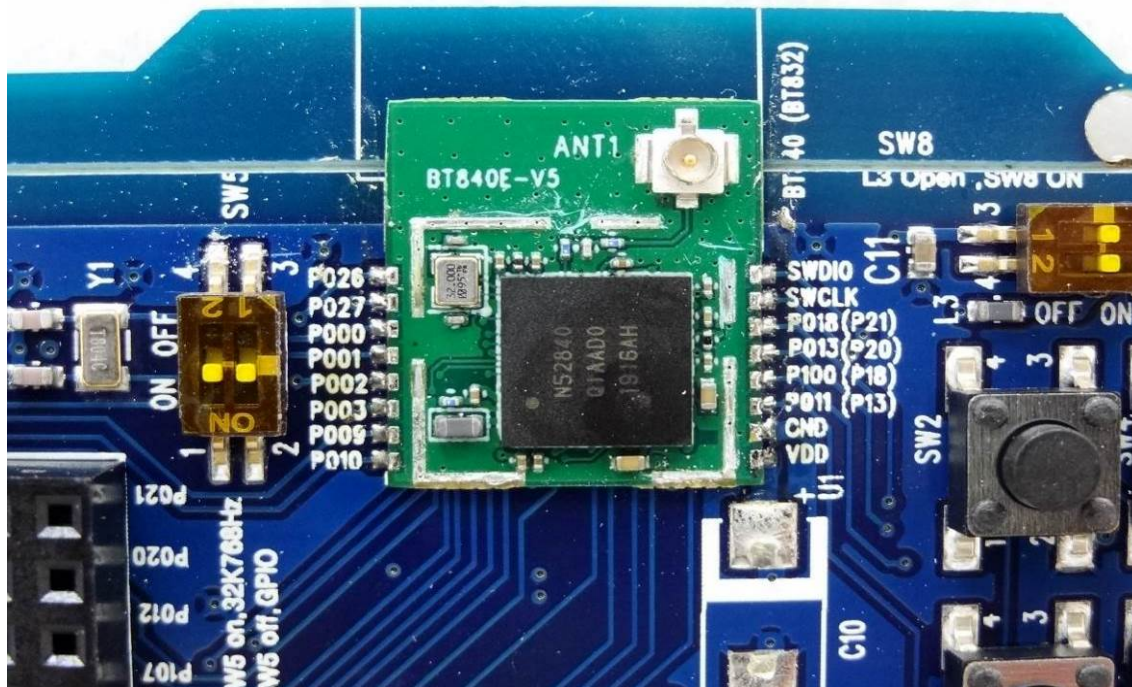




EUT 5 BT840



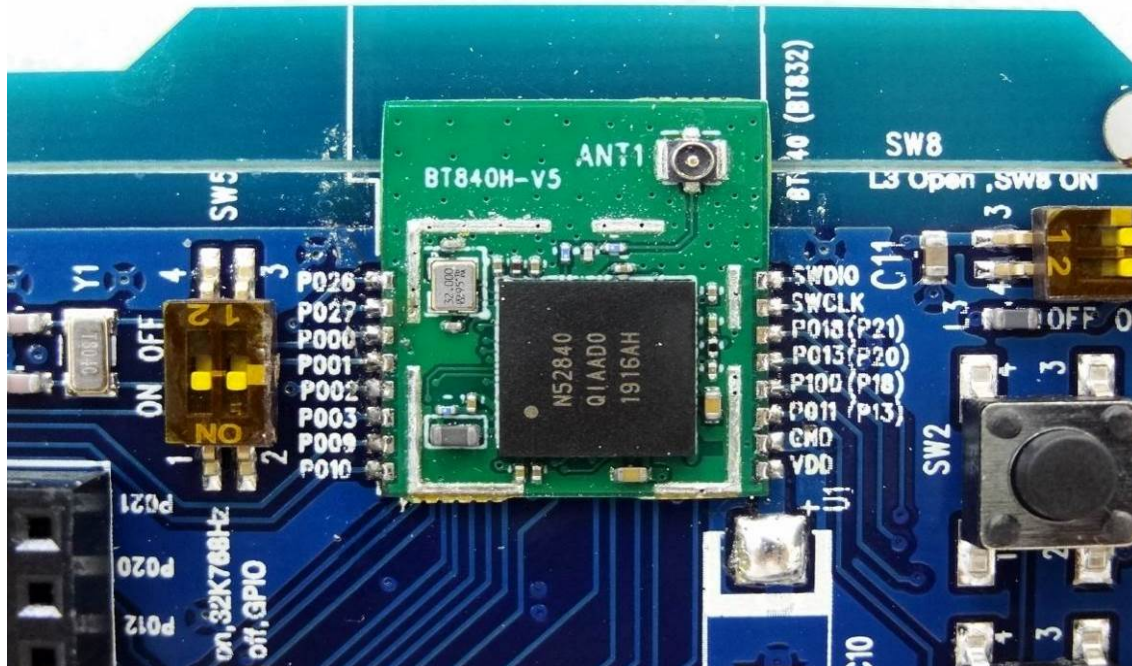
EUT 6 BT840E



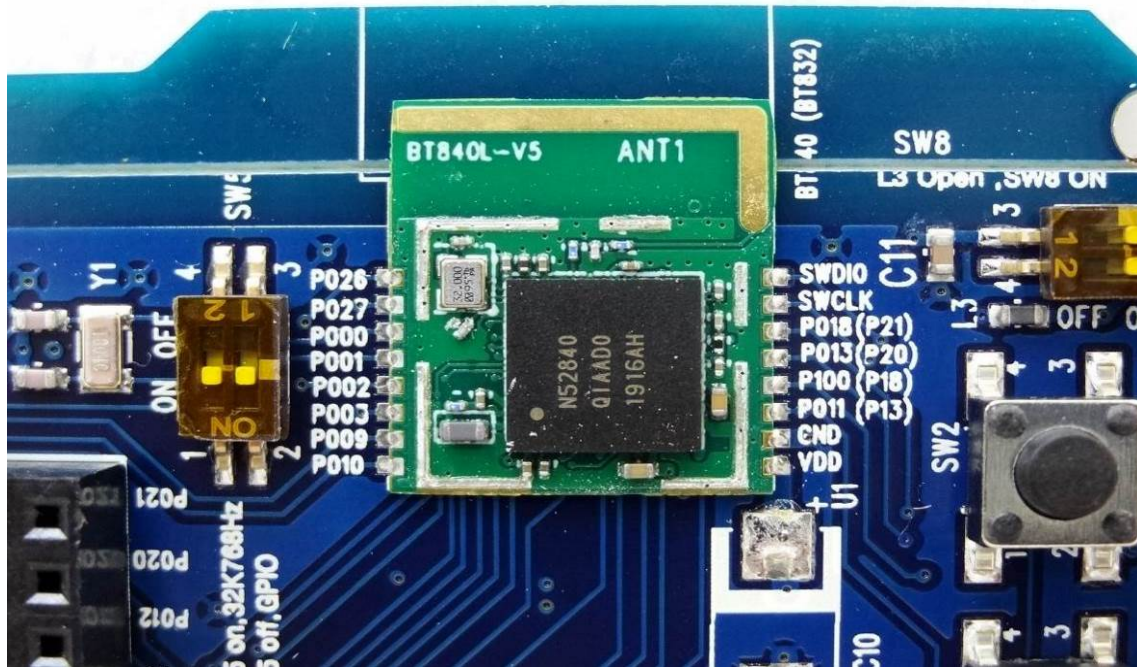
EUT 7 BT840F



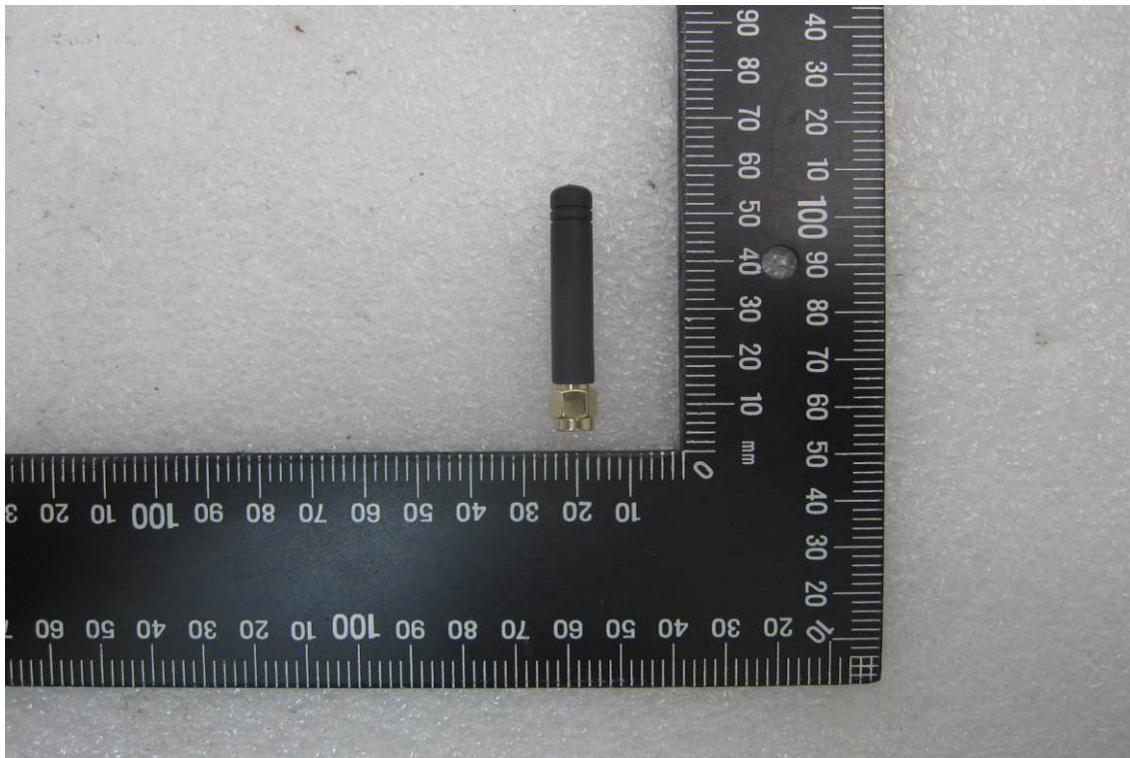
EUT 8 BT840H



*EUT 9 BT840*



*EUT 10*

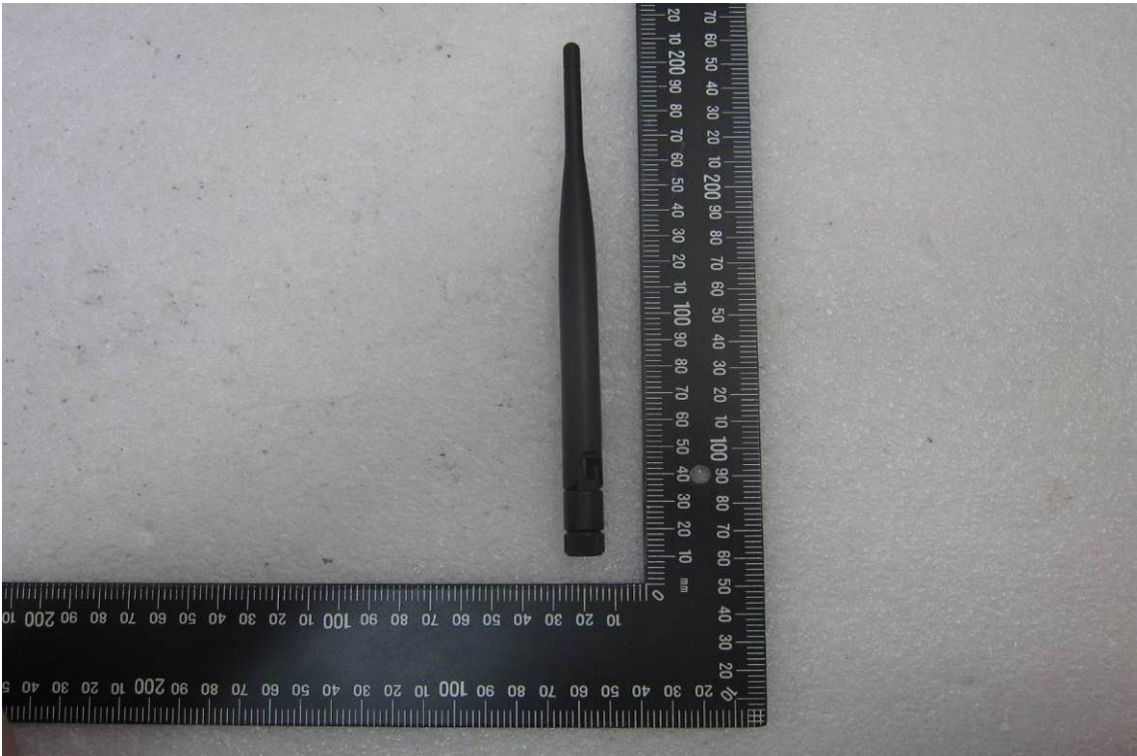




***EUT 11***



***EUT 12***



***EUT 13***



*~ End of Report ~*